

Eowave Ribbon MK2



12-bit Programmable Digital Synthesizer and USB/CV/Gate Controller

Important

If you are an early adopter of the Ribbon 2 (first half of 2016, the first batch) you will need to update the firmware to RIBBON2_v101.hex found here <http://www.eowave.com/members/Ribbon%20mk2/>

In this firmware update we have addressed some issues when using the Ribbon to send MIDI information over USB. If you are experiencing these problems, please update the firmware to v101

Updating the firmware is easy, and explained in full on p18 of the manual

Cautions

- Before using the Ribbon, make sure you have read the following instructions carefully, as well as the instructions for use
- Refer servicing to qualified service personal
- Do not try to repair the Ribbon. Please contact Eowave for technical support
- Avoid all sharp object contact on the Ribbon
- Do not use the Ribbon or store it under extreme temperature conditions or expose it to direct sunlight, damp or dusty areas, or areas prone to strong vibrations
- Before you plug in the Ribbon, always check the voltage
- Protect the Ribbon against violent shocks
- Before using the Ribbon in a foreign country, check if the voltage is compatible
- When the Ribbon is not used, disconnect the unit from its power supply
- Never place heavy objects on the Ribbon
- Never touch the Ribbon with wet hands when it is plugged in
- Before moving the Ribbon, make sure the unit is disconnected from other devices
- Before cleaning the Ribbon, make sure the unit is switched off and not plugged in
- During a lightning storm, unplug the Ribbon
- The Ribbon is not a lightsaber. It is not made for fighting
- Make sure your body is well isolated from the ground

Care of the Ribbon

- The Ribbon surface is fragile. Only use your finger to play it. Avoid playing with sharp objects - wood sticks, pens, chop sticks...
- Clean the Ribbon with a dry cloth. Never use any detergent or acetone on the pad or on the plexi enclosure.
- Clean the tactile pad and plexi enclosure with a dry cloth

Preliminary

What is the Ribbon?

Thank you for buying a Ribbon 2! With the Ribbon, we tried to create a unique instrument designed for modern musicians

At the same time a synth and a USB and CV/Gate controller, it can be used in many different ways - as a solo instrument, to control virtual instruments and iOS or to control analog/modular systems and CV/gate devices

With its plexi enclosure, Eowave Ribbon is a striking visual instrument perfect for live applications

If you have any questions, feel free to contact Eowave at info@eowave.com

Unpacking

Make sure that you have everything!
The Ribbon is delivered in a tube. You may keep this tube to store your Ribbon when it's not used or when you travel

The Ribbon is delivered with

- 1 mini USB cable
- 4 plastic pods

Join the Eowave users page!

Follow us on Facebook, and please share your videos and pictures with us at www.facebook.com/eowave

Using the Ribbon as a MiniSynth

The Ribbon has a sound generation section with an internal 12 bit digital oscillator. It can be used as a mini synth by plugging it to a sound system or thru your computer

Basic connections to your sound system

In the example below, the Ribbon is used as synthesizer instrument. It can be powered with a 5V DC USB power supply or via usb. Plug an audio cable from the audio out of the Ribbon to the audio in of your loud speaker or audio interface. Plug a mini USB to your computer or to a 5V DC power supply to the power. Note that plugging more than 5V power supply can destroy the unit. Cables and power supply can be found on www.eowave.com

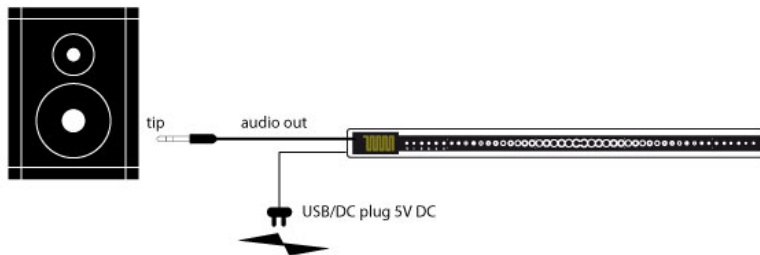

Basic connections to your computer

In the example below, the Ribbon is used as a controller instrument connected to your computer. The Ribbon is USB powered. Connect the Ribbon to your computer with the USB cable delivered with the Ribbon



Once plugged, the Ribbon is automatically recognized as a MIDI interface by your computer. It will appear under the name « Ribbon Mark2 »

How to play

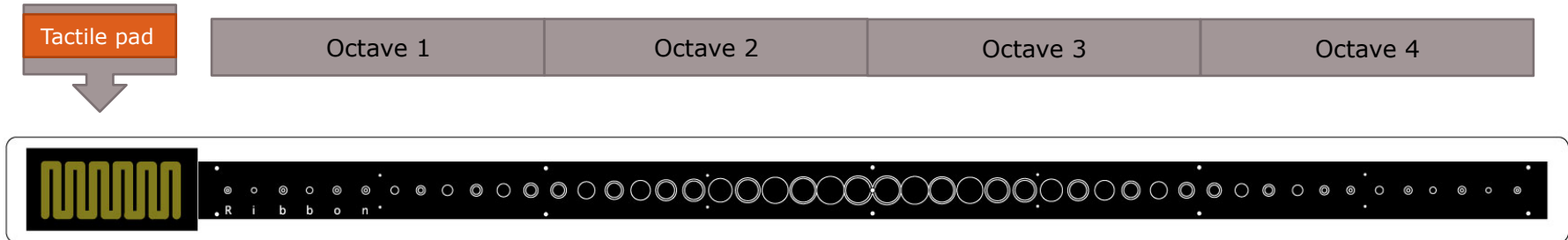

The Ribbon

The Ribbon is sensitive to position and to pressure. Gently press the Ribbon. The sound that you hear is generated by the oscillator coming from the Ribbon. The volume is controlled by the pressure applied onto the Ribbon. Note that in controller mode, it is possible to change the pressure destination using the Ribbon editor

About the notation printing

You can use the Ribbons notation markings (the circles printed on the surface) to play over 4 octaves. We calibrate each Ribbon, and the notes should be close to the intended pitch, but as the tolerance of each sensor is slightly different, perfect pitch on each mark is difficult to achieve

The tactile pad on the right or on the left?

Ribbon can be played with the tactile pad on the right or on the left. It is possible to invert the linearity of the Ribbon using the editor

Can I change the Ribbon's scale?

Yes, depending on how it is used (stand-alone or controller), the Ribbon has different scales settings, configurable in the editor

The tactile pad

The tactile pad controls either frequency modulation, amplitude modulation, or LFO modulation which you can configure using the editor. When pressing the tactile pad, the modulation amount increases. The pad is pressure sensitive. This means that the more you press onto it, the more the modulation increases

The tactile pad and resistive technology

The tactile pad uses a resistive technology that harnesses the natural resistance of your body. If you play with bare feet, the result may differ than when your body is isolated from the ground

- Note that bad isolation from the ground may be the cause of erratic sending of information or uncontrolled values
- Note that in the controller mode, it is possible to change the pad destination with the editor

Use the Ribbon as a USB controller

The Ribbon can be used as a USB controller. It is compatible with any MIDI software. No MIDI interface is needed. It's also fully compatible with Mac OSX/PC/Linux and iOS devices

Plug the Ribbon in to your computer via USB. The Ribbon is automatically recognized as a MIDI device by your computer. In your MIDI compatible software, it appears in the MIDI setup. Use the editor to configure the MIDI channel you wish to control



Control a parameter of a MIDI virtual instrument

In most cases, the Ribbon will be used to control the pitch of your virtual instrument. If you use the Ribbon as a controller, the pitch control setting will depend on your software or plug-in. Configure your software or your plug-in MIDI setup to receive pitchbend values from the Ribbon. Note that some software does not offer this possibility

Scaling the Ribbon (see editor section)

- Using USB, the Ribbon can be scaled with 4 modes: 4 octaves with half tones, 4 octaves continuous, 12 octaves with half tones or 12 octaves continuous
- Once again, the scaling depends on the software you use and if it allows +/- 24 semi tones or not. Some do not

Control a parameter with the Ribbon's tactile pad

In the editor, you can change the destination of the tactile pad so it receives MIDI informations from your MIDI devices. (Always check what MIDI parameters your MIDI devices allow to send)

Control a parameter with the Ribbon's pressure

In the editor, you can change the destination of the Ribbon's pressure so it receives MIDI informations from your MIDI devices. (Always check what MIDI parameters your MIDI devices allow to send)

Use the Ribbon as a CV/Gate controller

The Ribbon has an audio out that can be configured into a CV/gate controller with an audio cable. This way, the Ribbon can control a modular synthesizer directly. It sends V/oct signal. Range is from 0 to 5V and will be around 5 octaves. It is possible to use an attenuator module to send fewer octaves

Follow the diagram opposite, using a stereo cable from your Ribbon, into a y-jack converter (or a split lead). CV1 will go to your V/Oct input on an Oscillator or sound source, CV2 will go to an envelope or trigger source

CV1 is the position of the Ribbon sensor
CV2 can be controlled by the pressure of the Ribbon or by the tactile pad, configured using the editor

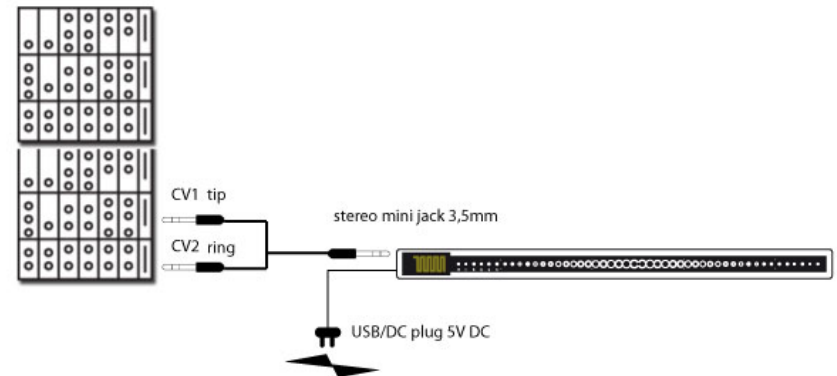

Use the Ribbon with your iOS

You can plug the Ribbon directly to your iPhone to control iPhone sounds. It will be automatically recognized

Plug the Ribbon to your iPhone with a USB cable. You can control any iOS MIDI app with the Ribbon

Settings

Install the editor

Before installing the editor, you need to download Max runtime from www.cycling74.com - It's free

Download the Ribbon mk2 editor from www.eowave.com/members

Plug in your Ribbon. Open the Mac/PC compatible editor. Hit the left hand button next to the drop down menu at the very top (<select Ribbon) and choose 'Ribbon Mark2' from the drop down menu. Your Ribbon is now synced. The right hand button beside the drop down menu will flash when you play the Ribbon

The previous sections of this manual have covered the basic operation of the Ribbon. There are many new functions and features in the mk2 configurable via the editor, which we will be covering from here on

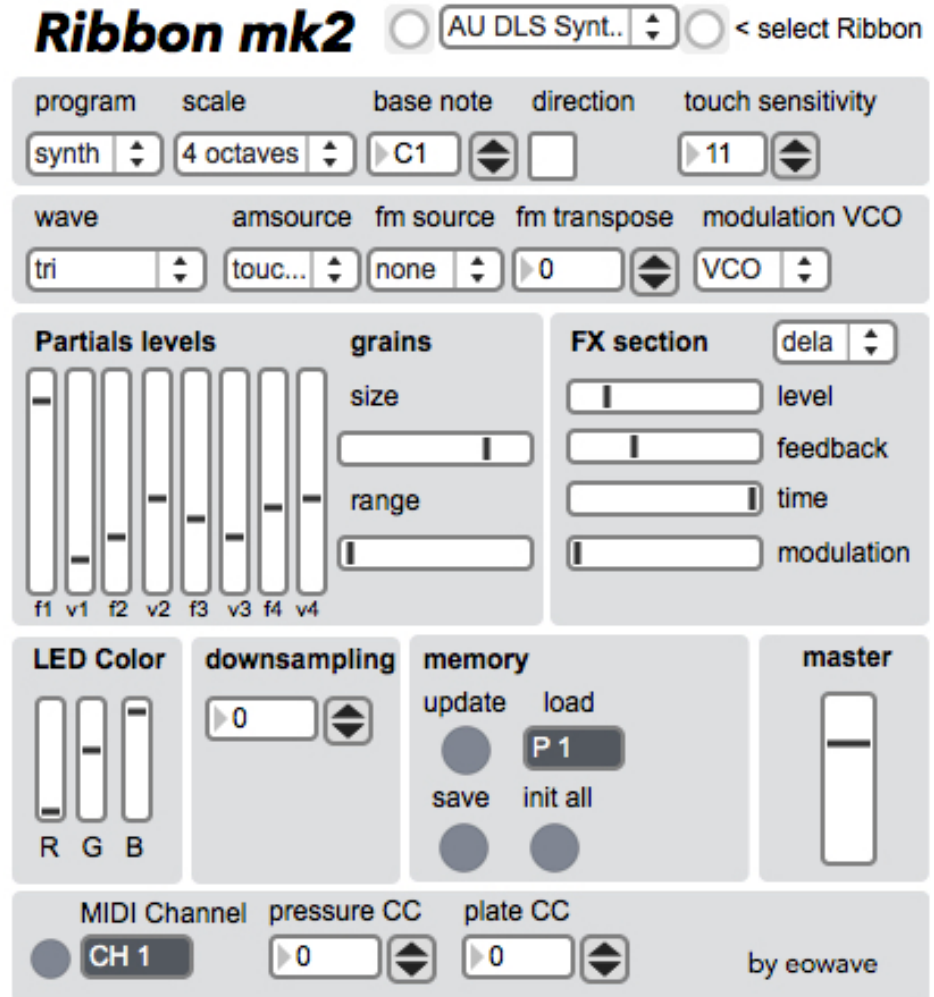

Using the Editor: MIDI and Presets

Creating presets

With the editor, you can store up to 16 settings presets. Once you've adjusted the settings, you can save them by selecting the preset number of your choice and hitting the save button. You can recall this preset by choosing the preset number from 'load' (P1-P16). The two buttons on your Ribbon behind the touchplate cycle up and down this list of presets

1. Select the preset using the numbered menu
2. Modify the parameters in the editor
3. Save to one of the 16 presets

You can re-load factory presets at any time using the 'init all' button. This will replace all 16 existing presets with the factory presets provided when you received the Ribbon

Note that preset 1 is the default preset when the unit is powered

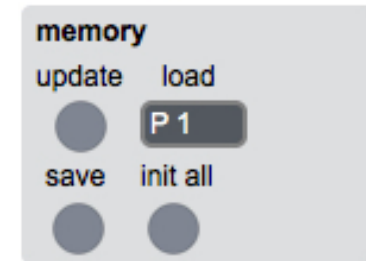

Using the editor

Working from the top down, we will look at the functions of the mk2 editor. An important note to make now, is that each time you change a parameter and want to hear the change on your Ribbon, **you must hit 'update' in the memory section** at the bottom. This will happen instantaneously and you will be able to hear the effect of your changes by playing the Ribbon

Top section

program – changes between synth and CV output programming

scale – allows you to define the scale of the ribbon, or change to pitch bend mode. Scale will be covered further in a few pages with regards to the USB controller mode

base note – defines your base note, click on the arrow or drag to set

direction – changes the orientation of low to high notes on the ribbon, for those that want to use the touch pad on the right side

touch sensitivity – you can adjust this parameter for to suit your playing style, try it with factory shipped settings first as the Ribbon may become more difficult to keep in tune if you increase the sensitivity too much

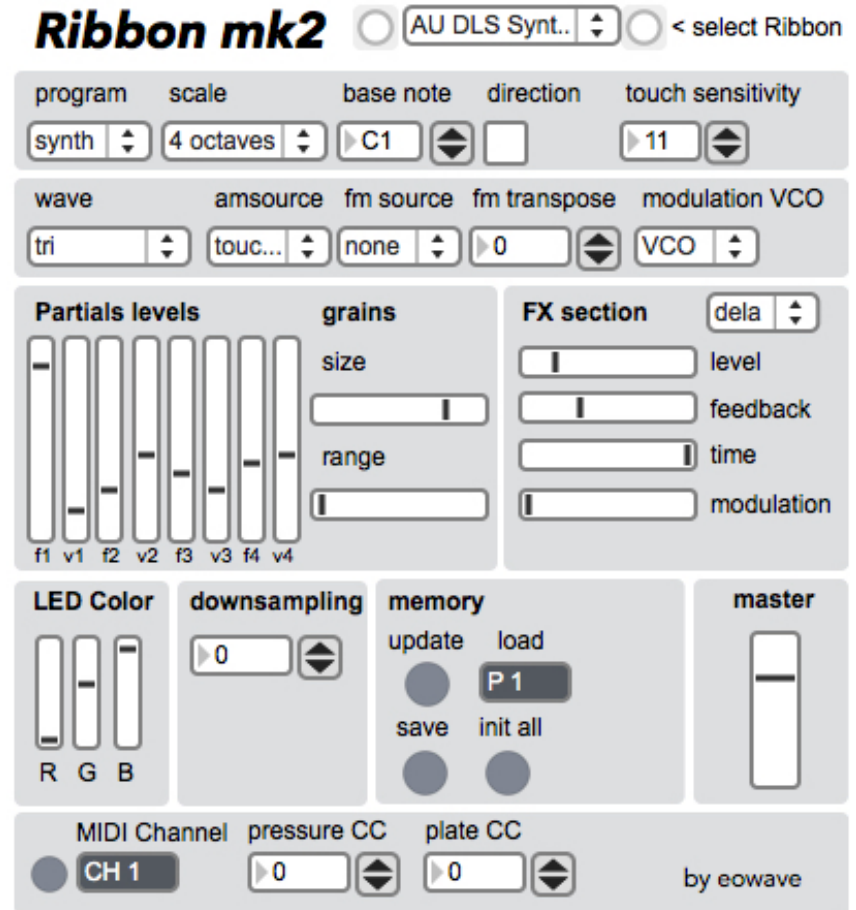

Using the editor

Section 2

wave – chooses the type of oscillator that your Ribbon will play. Choose from saw, square, triangle, sine, noise, pitched noise, additive synthesis, bell, grain

am source – choose the source of amplitude modulation. Usually this will be 'press' (short for pressure) from your ribbon sensor, but you can also set the 'touch' (touch plate) to control the amplitude modulation. AM has the effect of being a volume control (on and off) so with 'none' selected your Ribbon will continuously output sound from your oscillator

fm source – frequency modulation, experiment with none, press and touch to see how the sound responds

fm transpose – changes the note of the frequency modulation. This can make the fm modulation more extreme

modulation VCO – choose between VCO modulation (modulating the frequency of your VCO) or LFO modulation. When LFO modulation is selected, the fm transpose becomes your LFO rate

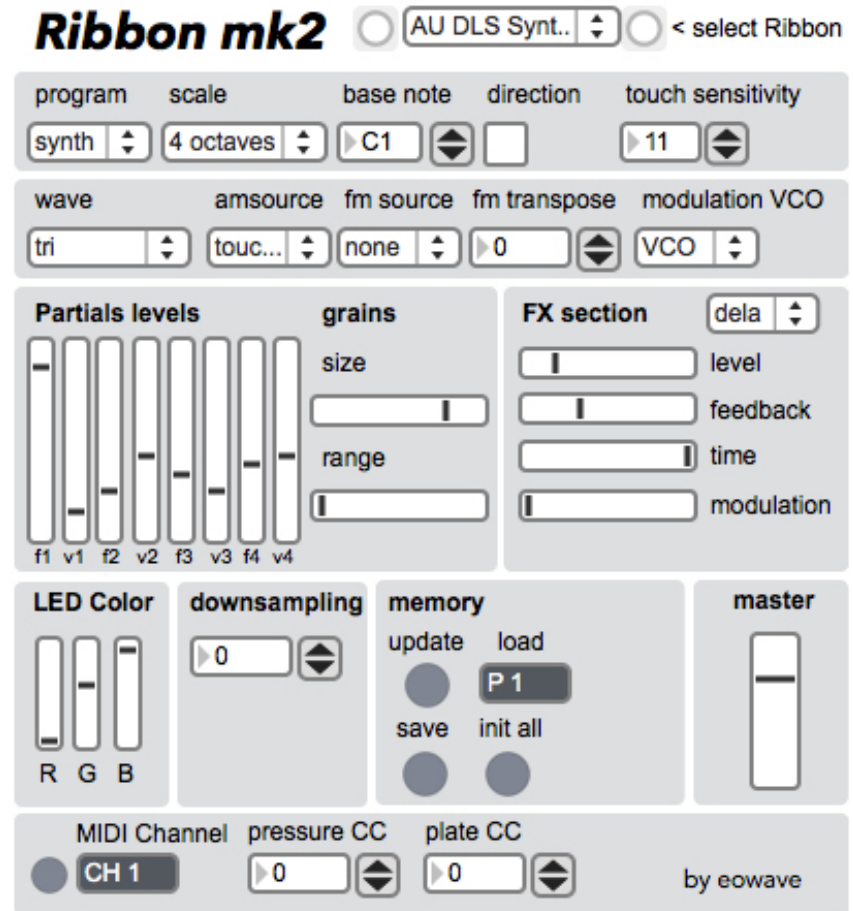

Using the editor

Section 3

partials levels – this feature works with the additive and bell wave modes. Experiment by adjusting the sliders and see how they affect the sound output of your Ribbon

grains – experiment with the size and range of the grains in the grains wave mode

FX section – turn the delay effect on or off at the top of this box. Set the level, feedback, time and modulation amount using the sliders

Section 4

LED colour – change the LED colour between presets using these sliders. You can make your presets recognisable with clear colouring

downsampling – downsamples from the processor creating a distorted, bit crushed effect. High levels will cause lag between playing time and audio output

memory – as already covered – update your parameters, save presets, load presets and restore factory presets in this section

master – using lots of effects and fm can result in louder output. Turn the master down to keep the output from clipping

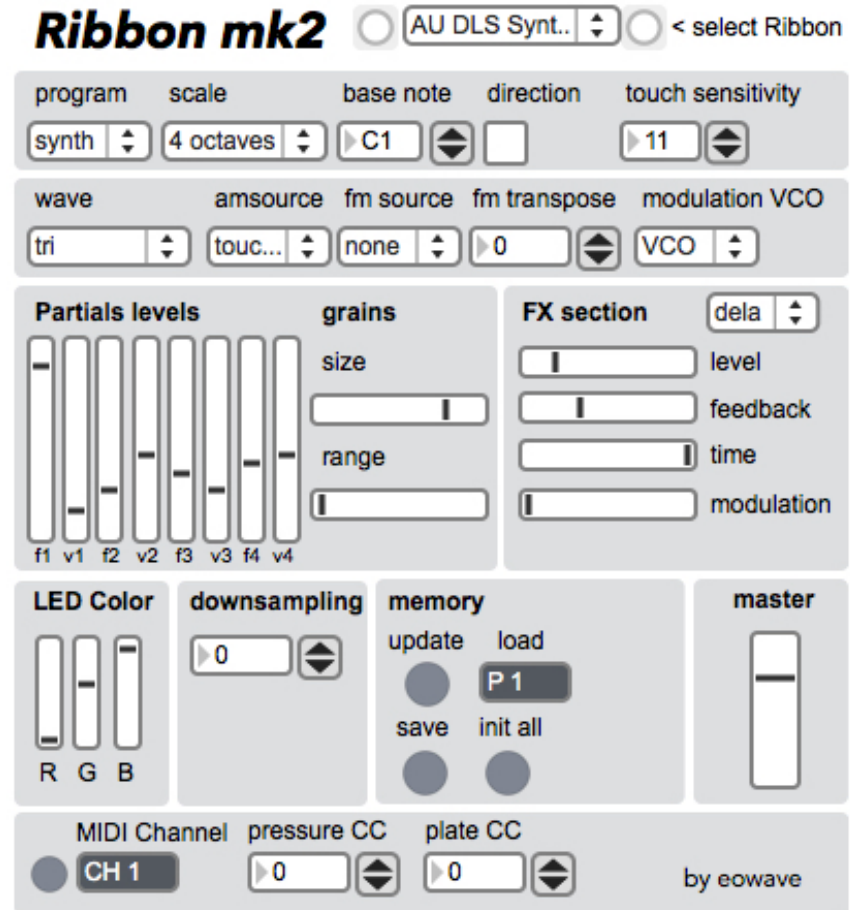

Using the editor

Section 5

The Midi settings of the Ribbon are Global and must be updated separately from the sound synthesis section using the button on the left hand side of section 5, directly next to the MIDI channel selection menu

MIDI Channel – select the MIDI channel in which you will be transmitting MIDI messages

pressure CC – selects the CC number that will be transmitted from the pressure sensor

plate CC – selects the CC number that will be sent from the touch plate

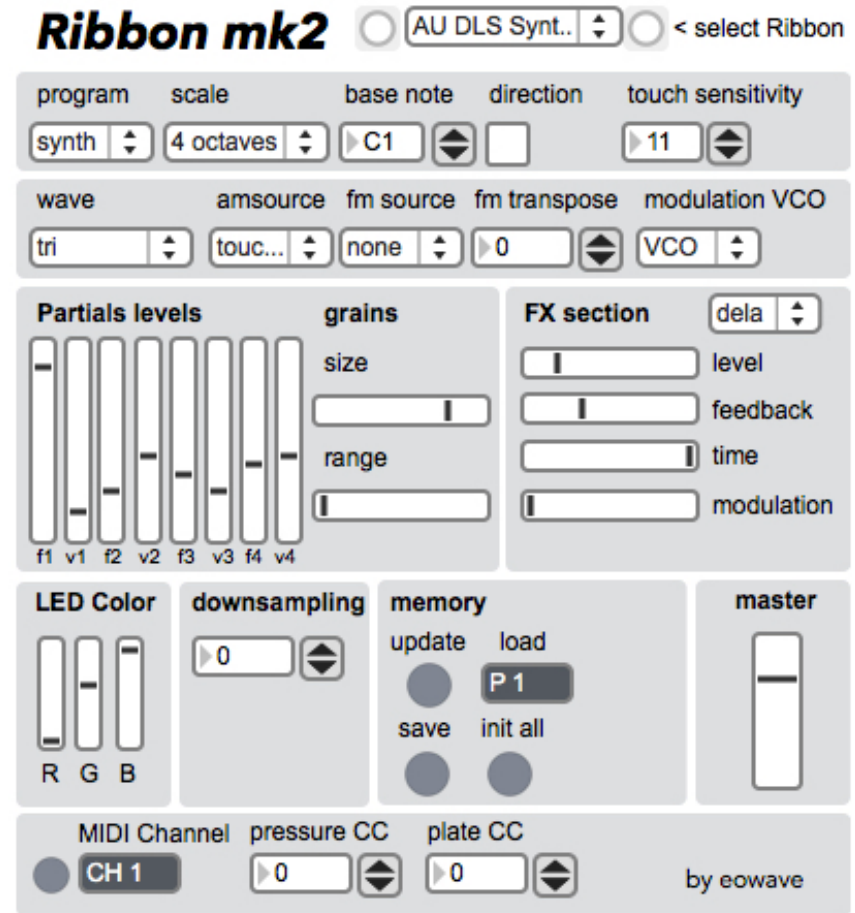

Settings scale parameters in the USB controller mode

The USB mode is always active. Once connected, USB sends MIDI information

Scale of the Ribbon

Limitations due to some virtual instruments

Note that virtual instruments are not all programmed to allow a continuous control of the pitch on a wide range. Some are limited to +/-2 halftones, most of them to +/-12 halftones, some others allow +/-24 halftones. Check on your virtual instrument manual to see what range it allows. According to the range your virtual instrument allows, the Ribbon will have a 4th, 2 or 4 octaves range.

This is not possible to get 4 octaves with a virtual instrument that allows only +/-2 halftones or +/-12 halftones

In USB mode, the Ribbon can be scaled with 4 modes:

Full scale continuous (12 octaves)

Sends the base note and the absolute pitchbend position

Full scale halftone (12 octaves)

Doesn't send pitchbend. Each times the Ribbon is pressed, it sends a note from 0 to 127

4 octaves continuous

Sends the nearest halftone in a 4 octaves range (starting at base note). If you keep the finger pressed and move it, it will send a relative pitchbend with 0 being the first position of your finger. To keep the same pitch after a glide or if you press the Ribbon a second time after a release, set the pitchbend range of your plug-in to +/- 24 half tones

4 octaves halftone

Doesn't send pitchbend. Each times the Ribbon is pressed, it sends 4 octaves starting at the base note

Velocity

In the four modes, the Ribbon sends a velocity of 127. The velocity is controlled continuously by the volume controller #7 on the pressure

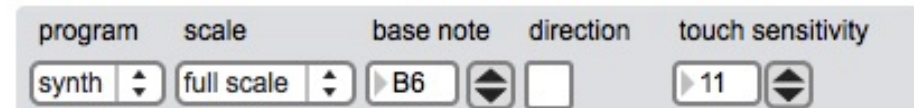

External control mode

Connect your Ribbon to your computer. Connect the audio out in the audio in of your sound system

To control the internal synthesizer with MIDI, send the following CC messages:

Pad : CC1

Pressure : CC7

Position: CC Pitchbend

Uploading firmware

You may need to update the firmware when we release a new version, or if you find you are having software problems with your Ribbon

The Ribbon firmware can be found at <http://eowave.com/members/> in the Ribbon 2 folder. You also need to download the HID bootloader app from the firmware folder. Select either PC or OSX version as required

Open the HID bootloader application. Hold the two buttons on your Ribbon while plugging the USB into your computer. A message should appear in the HID bootloader saying 'Device Ready'. Use the folder icon to select the firmware hex file. Then press the upload icon, which is on the right of the folder icon. The firmware should take a few seconds to upload, and will then ask you to reboot the device. Unplug and then plug in your Ribbon and the new firmware should be installed

If you have any technical details, please contact us at info@eowave.com

Specifications

- 50 cm position and pressure sensitive ribbon
- 12 bit digital oscillator
- Tactile resistive pad
- USB
- Audio/CV out
- Dimensions : 63 x 4 x 1,5 cm
- Weight : 480 g (680 g with packaging)

CE norm & FCC INFORMATION

1. Important notice: do not modify this unit! This product, when installed as indicated in the instructions contained in this manual, is compatible with the CE norm & FCC requirements.

2. When connecting this product to accessories and/or another product, use only high quality shielded cables. Cables supplied with this product must be used. Follow all installation instructions. Failure to follow instructions could void your FCC authorisation to use this product in the USA.

Note: this product has been tested and found to comply with the requirements listed in FCC Regulations, Part 15 for Class B digital devices & in The European Standard EN 50081-1 on Electromagnetic Compatibility - Generic emission standard on residential, commercial and light industry. Compliance with these requirements provides a reasonable level of assurance that the use of this product in a residential environment will not result in harmful interference with other electronic devices.

Eowave

www.eowave.com

info@eowave.com