

## OWNERS MANUAL

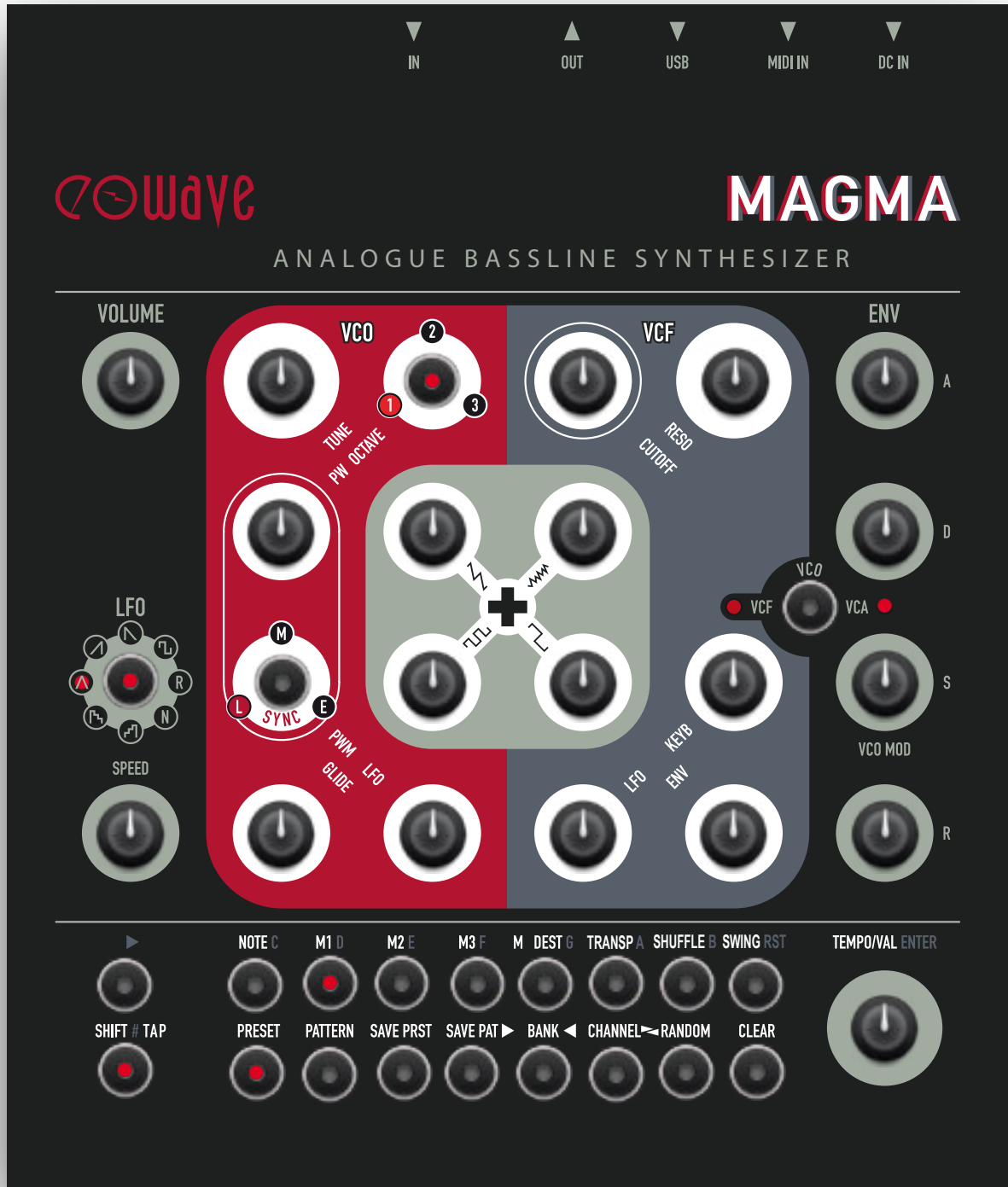



## SAFETY INSTRUCTIONS

Before using MAGMA, please follow the instructions for use of the instrument as this will warrant proper operation of the instrument. Due to the fact that these instructions touch on product liability, we recommend you reading them carefully. Any claim for defect will be rejected if one or more of the topics have not been observed. Ignoring the instructions can eventually void warranty.

- RISK OF ELECTRIC SHOCK! DO NOT OPEN OR MODIFY MAGMA.
- REFER SERVICING TO QUALIFIED SERVICE PERSONNEL ONLY.
- TO REDUCE THE RISK OF ELECTRIC SHOCK, DO NOT REMOVE COVER (OR BACK). NO USER-SERVICEABLE PARTS INSIDE.
- The instrument may only be operated at the voltage noted on the power input on the rear panel. Before plugging in MAGMA, always check for the correct voltage. Before using MAGMA in a foreign country, check whether the mains voltage is compatible with the unit.
- When MAGMA is not in use, disconnect the power supply from the power outlet. This will save energy (and keep your electric bill within reason).
- Never attempt to repair MAGMA on your own. Never open the casing. For technical support, please get in touch with Eowave.
- The instrument is not to be operated outdoors (never ever!) but in dry, closed rooms only. Never use the instrument in a moist or wet environment or near flammable materials.
- No liquids or conductive materials must get into the instrument. If this happens to be the case, the instrument is to be disconnected from mains power immediately and examined, cleaned, and eventually repaired by a qualified person (that would be us).
- Never expose the instrument to temperatures above +50 °C or below -10 °C. Before powering up, the instrument should have a temperature of at least +10 °C. Do not place the instrument in direct sun light. Do not install the instrument near heat sources such as radiators, open fire places, or thermo-nuclear testing sites (or power plants that would employ people like Homer Simpson).
- Keep the top of the instrument clear in order to warrant proper ventilation, otherwise the instrument may overheat and malfunction.

- Never place heavy objects such as beer crates, trucks, or mothers-in-law on the instrument.
- Before moving place with MAGMA, make sure the unit is disconnected from other devices (external controllers, mixers etc.). If not, watch for cables and other pitfalls. Funny films can be uploaded to the internet.
- Transport the instrument carefully, never let it drop or be rude to it. Make sure that, during transport and while in use, the instrument is properly supported (no pizza cartons or king-size buckets of chicken-wings) and cannot fall or slip from your (possibly greasy) fingers – people might get injured and, even worse, sue you for this.
- Never use the instrument in the immediate proximity of interfering electronic devices (e.g. computers and monitors, power supplies, speakers, flux compensators, or hadron colliders) since this might cause MAGMA to behave erratically – and may result in corrupted memory data as well.
- Before cleaning MAGMA, make sure the unit has been unplugged. Use a soft, dry cloth only to clean MAGMA. Never use any liquids, abrasive cleaners or cleaners containing solvents such as alcohol, turpentine, or other spirits (such as Scotch Single Malts in cask strength).
- The instrument is to be shipped in the original packaging only. Any instruments shipped to us for return, exchange, repairs covered under warranty, update or examination must be in their original packaging! Any other deliveries will be rejected. Therefore, you should keep the original packaging and this user documentation – if only as a doorstop.
- The instrument may only be used for the purpose described in this operating manual. Due to safety reasons, the instrument is never to be used for purposes other than musical (e. g. disintegrating neighbours, bending the space-time continuum, impressing girls etc.).
- When using the instrument in Germany, ACHTUNG: the appropriate VDE standards are to be obeyed. The following standards are of special and utmost importance: DIN VDE 0100 (Teil 300/11.85, Teil 410/11.83, Teil 481/10.87), DIN VDE 0532 (Teil 1/03.82), DIN VDE 0550 (Teil 1/12.69), DIN VDE 0551 (05.72), DIN VDE 0551e (06.75), DIN VDE 0700 (Teil 1/02.81, Teil 207/10.82), DIN VDE 0711 (Teil 500/10.89), DIN VDE 0860 (05.89), DIN VDE 0869 (01.85). VDE papers can be obtained from the VDE-Verlag GmbH, Berlin. German readers will know where to turn to, all others do not really need to bother.

WELCOME TO THE



VERS 1.0

# OWNERS MANUAL



## CONTENT

|  |           |                                  |           |
|--|-----------|----------------------------------|-----------|
| <b>1. INTRODUCTION</b>                 | <b>6</b>  | <b>5. SOUND GENERATION</b>       | <b>34</b> |
| 1.1. Preface                           | 6         | 5.1. Sound Generation Overview   | 34        |
| <b>2. GETTING STARTED</b>              | <b>7</b>  | 5.2. Oscillator (VCO) / Mixer    | 36        |
| 2.1. Manual Conventions                | 7         | 5.3. Filter (VCF)                | 37        |
| 2.2. Preparations                      | 8         | 5.4. Amplifier (VCA)             | 38        |
| 2.3. Connections                       | 9         | 5.6. Envelope section            | 38        |
| 2.4. Check it out / First encounter    | 10        | 5.7. LFOs                        | 39        |
| <b>3. OVERVIEW</b>                     | <b>12</b> | <b>6. MIDI FUNCTIONS</b>         | <b>41</b> |
| 3.1. Software controlled functions     | 12        | 6.1. MIDI Connections            | 41        |
| 3.2. Sound generation controls         | 13        | 6.2. MIDI Clock Sync             | 41        |
| 3.3. Sound generation / Signalpath     | 14        | 6.3. Real-time Transposition     | 42        |
| <b>4. PROGRAMMING SECTION</b>          | <b>15</b> | 6.4. MIDI Controller processing  | 42        |
| 4.2. Programming a preset              | 17        | 6.5. Program change processing   | 42        |
| 4.3. Saving Presets                    | 25        | 6.6. Sending out sequencer notes | 42        |
| 4.4. Save Patterns                     | 26        | <b>7. APPENDIX</b>               | <b>43</b> |
| 4.5. Clearing Notes, Presets, Patterns | 27        |                                  |           |
| 4.6. Transpose Menu                    | 28        |                                  |           |
| 4.7. Clock Divider                     | 30        |                                  |           |
| 4.8. Chaining Patterns                 | 31        |                                  |           |
| 4.9. MIDI Channel                      | 32        |                                  |           |

## 1. INTRODUCTION

## 1.1. Preface

„Magma (from Greek μάγμα „mixture“) is a mixture of molten or semi-fluid rock, volatiles and solids that is to be found beneath the surface of Mother Earth (peace, man!). Magma is a complex substance, fluid at excessively high temperatures. Temperatures of most magmas are in the range of 700°C to 1300°C (or 1300°F to 2400°F). Hot stuff, this.

That's what Wikipedia knows about magma... Your MAGMA is not fluid and a bit less hot (you can – and ought to – touch it with your hands without being harmed) but hopefully, your music will become even hotter (there you go again!) and fluid with the little help of this very machine you have just purchased. Eowave says THANK YOU, and congratulations on your excellent taste in electronic music equipment! Now you are the owner of your own bit of MAGMA! Enjoy exploring and playing it. And no, we will not call you Mother Earth (peace, man!).

**What's this?**

MAGMA is a monophonic analogue synthesizer with a built-in step sequencer, USB and MIDI interface. Its entire sound generation is made up of 100 percent of authentic analogue artistry. Only its modulation sources, the on-board sequencer, and the USB / MIDI interface use – of course – digital component parts. MAGMA is housed in a rugged black sheet-metal case. Only high-quality potentiometers (often referred to as pot, in case you were wondering where the shrooms are hidden...) with solid metal shafts have been used for endless hours of joyful tweaking. Each pot has been mounted firmly to the chassis. MAGMA looks as beautiful as it sounds and is made for extensive live tweaking sessions. You will have all the advantages of analogue sound-generation as well as direct access to all crucial parameters. The built-in sequencer makes MAGMA independent from other external sequencers or computers – of course it is easy to tie MAGMA up to a computer or any other MIDI-equipped gear, should you feel so inclined.

Even though we call MAGMA a "bass-line synthesiser", it is not limited to bass (or lines) exclusively. There is a lot more sonic potential you will encounter while studying this manual and exploring MAGMA. Sound-wise, MAGMA will instantly make you hark back to the sounds of the 1980s. Its sound-engine is inspired by Roland's famous SH series of synthesizers which also featured mixable waveforms and an on-board sequencer. To this formula we have added contemporary controls and an on-board memory loaded with 256 presets. Yet, the idea behind MAGMA was not to make another copy of a vintage synthesiser, but to build a new synthesiser which marries the best of today's analogue and digital technology. We wanted to build a synthesiser with a very special timbral footprint that would conjure up images of something like "earthy", warm, thick, glurpy (thanks, Robert R.!), and „fat“ (without „ph“, fellows!).

MAGMA is made in France. All units were assembled by hand and, bien sur, lovingly checked and tuned to specs by Eowave.

**One more thing: Read this fascinating manual!**

We knew it, user manuals are your first choice in literature, and „War and Peace“ has become a bit of an old hat to you, hasn't it? Hey, that is fantastic – we are talking the same language here! And that is not only the language in which William S. wrote his Sonnets.

If you are in doubt about the entertaining qualities of this manual – how dare you! –, please bear in mind that its thorough study will eventually turn out to be quite useful, as it will highly increase the entertaining qualities of your new synthesizer as well. So please do yourself - and us - a big favour: Read (and possibly understand) this awesome manual! Bless you for your efforts!

In the first section you will find all information needed to hook up MAGMA to your setup. After that, you will find a brief overview of its functions. Synthesiser experts may use this as a quick-start guide. You should not skip the complete description of the entire „functions“ section in the next chapter, though - MAGMA hides some interesting features.

A little less conversation, a little more action – here we go...

## 2. GETTING STARTED

## 2.1. Manual Conventions

To make this manual most clearly to understand, we made some conventions:

Control elements that have to be tweaked, are always tagged in bold capital letters like these examples:

- **SHIFT** button
- **CUTOFF** control
- **TEMPO/VAL** encoder
- **LFO LED**

To execute a specific procedure, you will find instructions tagged like this:

- Hit **SHIFT** (hold) + **PRESET**  
Meaning: Hit the **SHIFT** button first, and keep it depressed while you hit the **PRESET** button.
- Hit **STEP 1** + Hit **STEP 5** + Turn **CUTOFF**  
Meaning: Hit **STEP 1** button first (please!), then hit **STEP 5** button, and then turn the **CUTOFF** control.
- Hit **BUTTON X** or turn **VALUE**  
Meaning: There is a choice between two or more alternatives to perform the described programming step, e.g. it is up to you whether you use buttons or the value encoder to select a function.
- Hit **ENTER**  
Meaning: Hit the encoder in order to confirm a function.

Mostly you will find some additional graphics to show you the necessary programming steps. These graphics will look like this:



Meaning: Hit a button first, and keep it depressed while you hit a second button.

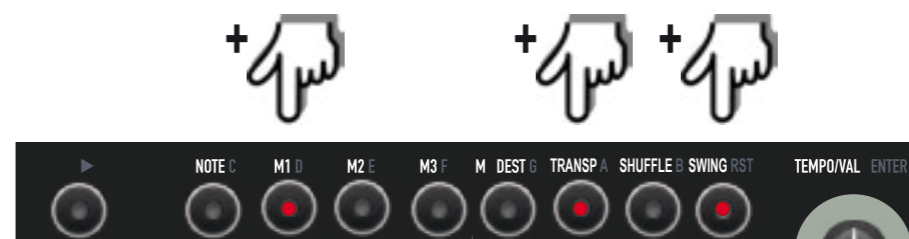

Meaning: Hit several buttons successively.



Meaning: Turn the VALUE encoder (to select a funktion / enter a value).



*Important hints are labelled like this:  
Please make sure that you read and understand this manual – thank you!*

## 2.2. Preparations

### 2.2.1. Unpacking

When gently lifting MAGMA out of its box for the first time, please make sure that everything is in its right place. You will find the following component parts in the box:

- MAGMA Synthesizer
- wall-wart (15VAC/800mA)
- this owners' manual

Also required:

- A suitable audio system (mixer, amplifier, speaker, or keyboard amp) or a headphone with mono-adaptor.

To connect MAGMA to a MIDI-keyboard and / or computer with suitable MIDI sequencer application, you will also need:

- A USB cable or MIDI cable to connect a suitable MIDI controlling device / keyboard / computer to MAGMA.

### 2.2.2. Setup

Use MAGMA in a flat position. Please use a suitable support. Used pizza cartons or beer crates won't do a proper job. Yes, this advice has become a bit redundant by now...

## 2.3. Connections

MAGMA is designed as a stand-alone device. All you need to use MAGMA is the power-supply and a suitable audio system or a headphone respectively (a little love can't do any harm, either). Make use of the additional connection terminals and you will expand MAGMA's potential a great deal. The connections are located on the far side of the control panel (that would be the back panel, of course).

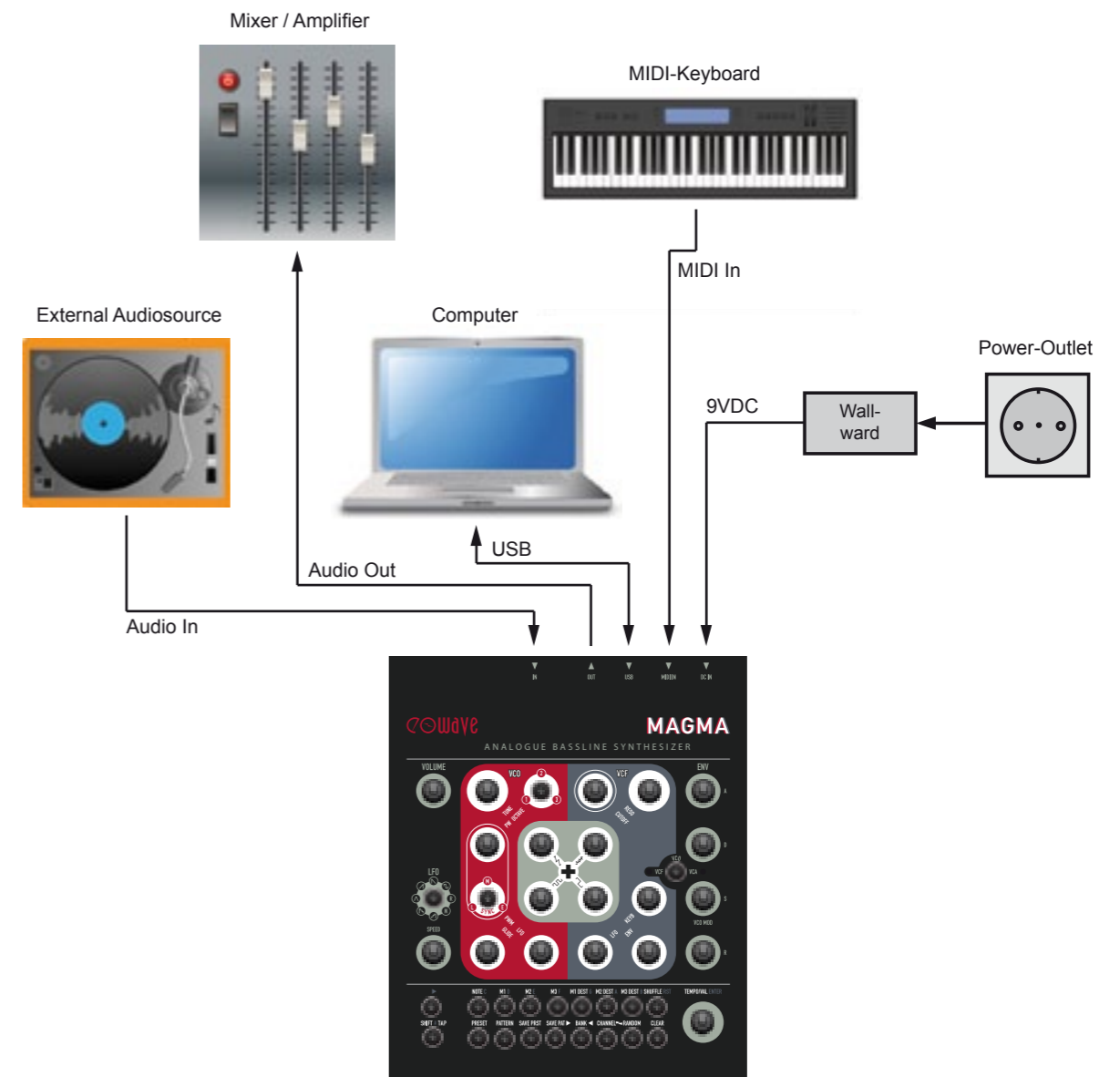

- DC IN: MAGMA uses an external DC - 15 V – 0,8 A power supply. Use the power supply provided with the unit. Important: Use this power adaptor only or an equivalent one with exactly the same specs!
- Connect the power supply to the instrument first and to the power outlet next. There is no dedicated power switch. As soon as the power adaptor has been plugged in, MAGMA will power up.
- In order to save speakers and ear-drums from blowing, turn MAGMA's **VOLUME** control fully counter-clockwise before powering MAGMA up.
- IN: Audio input to process external signals with.
- OUT: Audio output. Connect it to your audio system's input. Can also be used as a headphone output.

- USB: For MIDI via USB and firmware updates.
- MIDI IN: To control MAGMA from MIDI devices not equipped with USB.
- If you want to synchronise MAGMA with an external MIDI device via MIDI clock, connect the MIDI output of the respective device to the MIDI input of MAGMA and send a MIDI-clock signal to MAGMA.
- If you want to play MAGMA from a keyboard, connect the MIDI output of the keyboard to the MIDI input of MAGMA.

The default MIDI channel setting is 1 and should not be messed with at this point.



Please note that USB port and MIDI sockets should not be connected at the same time.



One short but important note about MIDI loops:

When using MAGMA in connection with a software MIDI sequencer, please make sure that the MIDI-through function of your software sequencer has been disabled, at least on the MIDI channel that is used by MAGMA. Otherwise, MIDI data (sequencer notes) output by MAGMA are fed back into MAGMA, causing data overflow and thus erratic behaviour. Especially users of Steinberg Cubase should keep an eye on this, since Cubase causes a MIDI loop when using its default settings.

#### 2.4. Check it out / First encounter (of a closer kind)

You are pretty curious to hear some sounds now, aren't you? Because of your (perfectly understandable) impatience, we will first go on a quick tour at this point. The following section will teach you how to load some presets, run sequences and tweak some pre-programmed sounds. Everything else will be covered later. Here we go:

- First turn down MAGMA's **VOLUME** control fully counter-clockwise.
- Power MAGMA up.
- Turn up **VOLUME** to a suitable level. When it hurts, it is probably a tad too much.

When running MAGMA together with a mixer, turn MAGMA's VOLUME up to the max and adjust the input level on your mixer. This will yield the best signal-to-noise ratio possible.

As you might have guessed by now, MAGMA is a monophonic synthesiser with an on-board sequencer. So what could be more obvious than checking out some sequencer patterns and listen to the sounds. Here we go (again):

- Hit the **START/STOP** button.
- You will hear the machine playing and you will see the **STEP** buttons / **LEDs** light up. Pretty nice, huh?
- Choose an adequate tempo by moving **TEMPO/VAL**.
- To stop the sequencer, simply hit **START/STOP** again.

Now that we have got your attention, you might want to listen to some more presets. Go on like this:

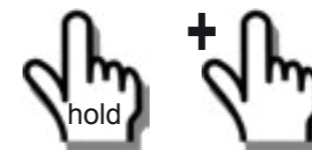

You already guessed it - hit **SHIFT** and keep it depressed while hitting **PRESET**.

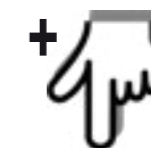

or



Pattern 1 – 8



Subbank 1 – 8



Then hit one button of the lower row to select a sub-bank. Keep it depressed while hitting one button of the upper row – now you have changed sub-banks as well as presets. Have your go at it and try out presets as you desire – enjoy!

To change tempo, leave the preset mode by pressing **SHIFT** and hitting **NOTE** (because in this mode, the encoder will change presets). Now you are back in note mode and the **VAL** encoder adjusts the tempo.

Connect a MIDI keyboard to MAGMA via MIDI DIN connection. Set the MIDI channel of your keyboard to #1. Now play some keys. The current sequence is transposed depending on the keys played. Please note that keyboard velocity controls the volume of the sequence.

While a preset is active, you may also tweak the sounds by turning MAGMA's knobs. Feel free to experiment.

All explanations about sound generation and programming the sequencer will follow later on.



### 3. OVERVIEW

Here you will find a brief overview of MAGMA's functions. Yes, it is all hidden in these two pictures, but you will most likely need some more advice to unveil all of MAGMA's secrets. So please keep on reading! There is much more to it than half-molten and semi-fluid rocks etc.

#### 3.1. Software controlled functions

The lower section contains all the software-controlled functions. These control presets, patterns, and the programming of the sequencer. Some additional functions like MIDI channel selection are also to be found here. All function groups are accessed by using certain combinations of buttons. We will plunge into this right away...

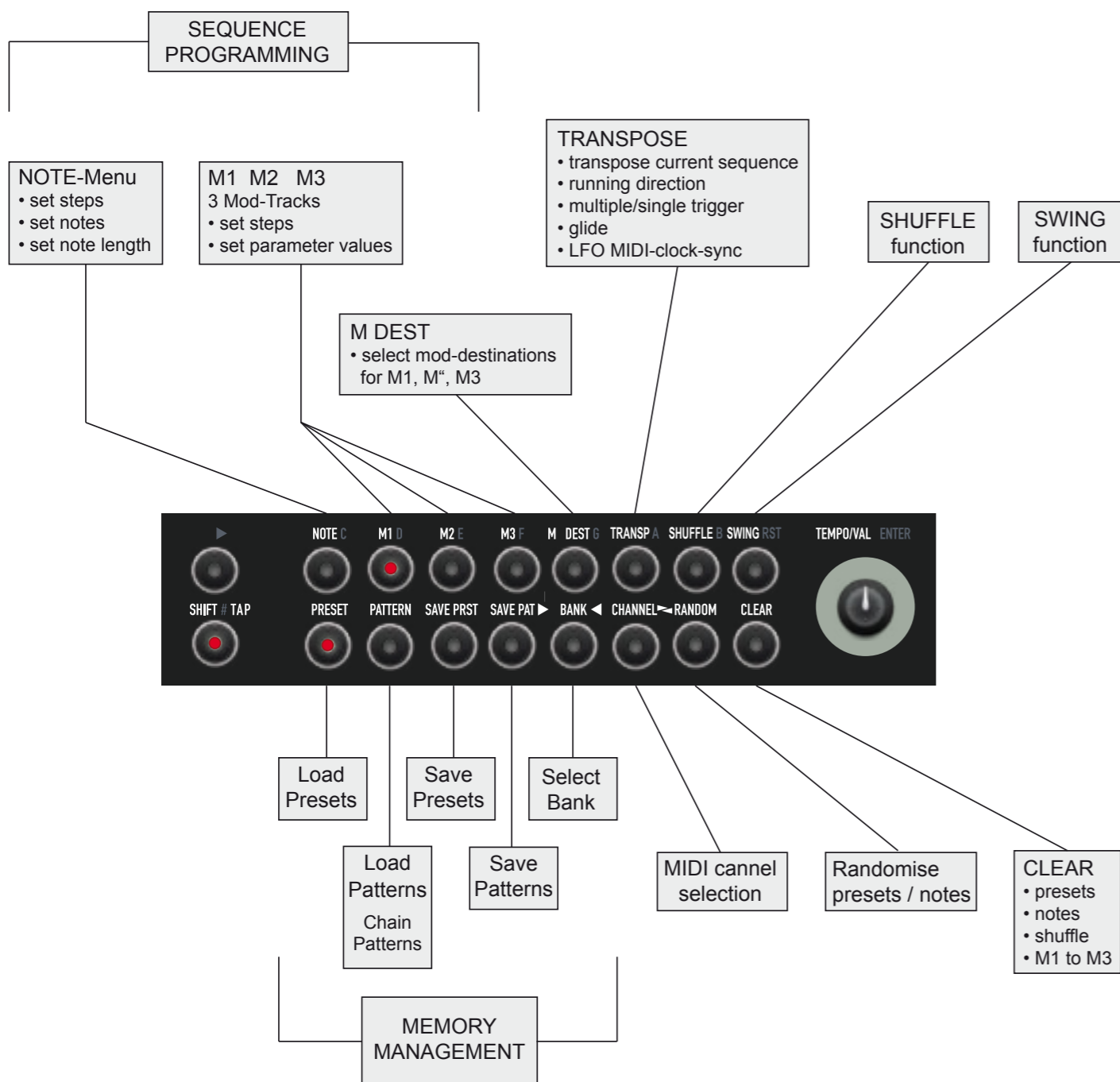

#### 3.2. Sound generation controls

But before this, let's have a look at the upper (or central) section. It contains all the controls of MAGMA's sound generation. Most of the controls have direct access to just one single parameter, labelled on MAGMA's surface. The buttons access multiple functions, displayed by specific LED combinations.

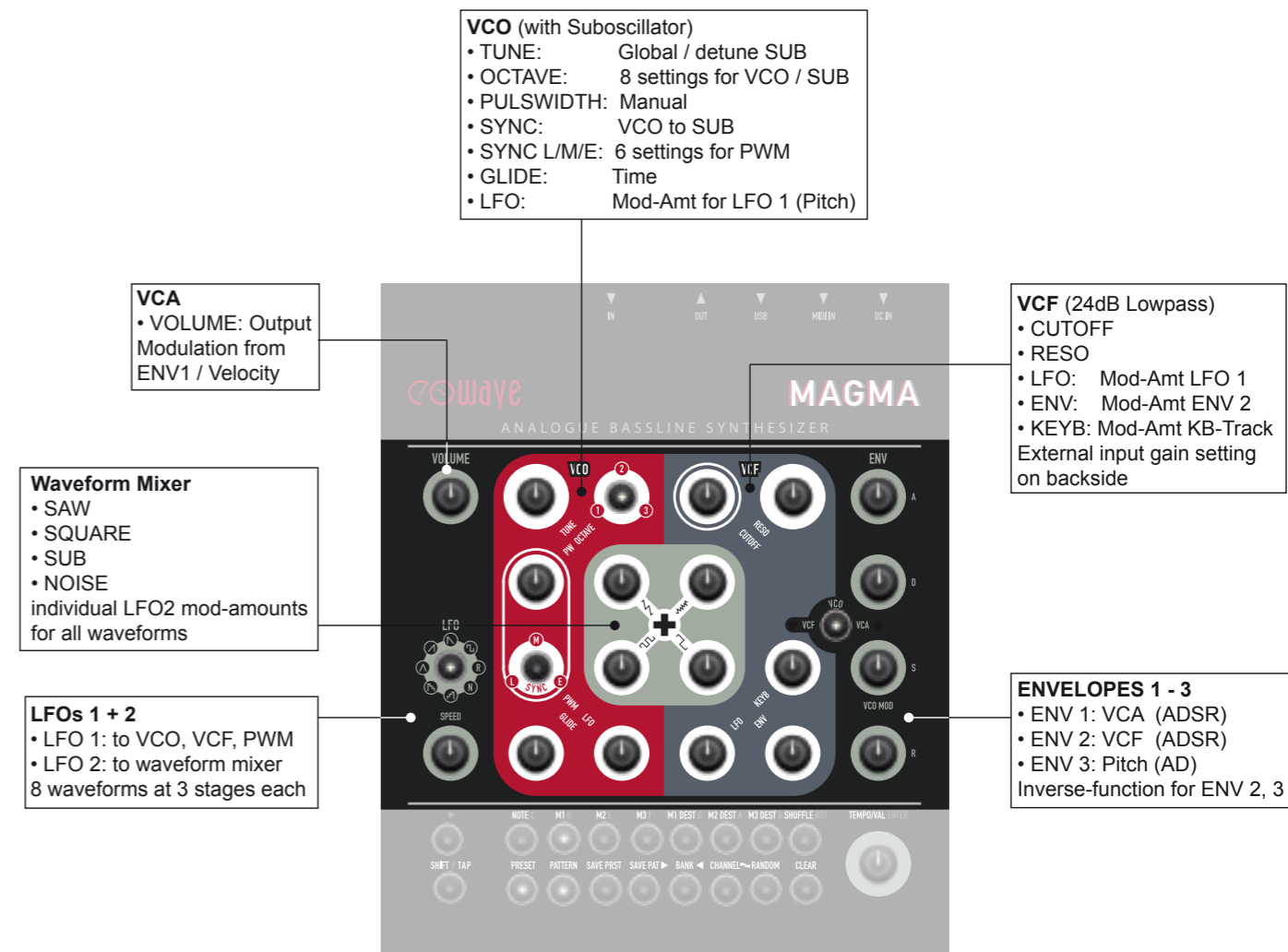



### 3.3. Sound generation / Signalpath

This is what is to be found under the hood of MAGMA's sound generation. All sections are labelled in a specific colour, corresponding to MAGMA's front-panel layout.

The sound sources are the voltage-controlled oscillator (VCO) and a sub-oscillator (SUB), phase-synced to the VCO. They put their waveforms into the mixer and further into the voltage-controlled filter (VCF) and the voltage-controlled amplifier (VCA). There is also an external input fed into the filter / amplifier. Have a look at the two envelope generators and the way they are connected to their destinations: ENV2 controls the VCA, ENV1 can be inverted and controls VCF and VCO pitch. LFO 2 controls the mixer, LFO 1 is connected to VCO pitch as well as to the pulse-width of the square-wave. Its modulation curve can also be inverted. At least we find MIDI data (or the on-board sequencer respectively), controlling pitch and triggering ENV 2 to generate notes.

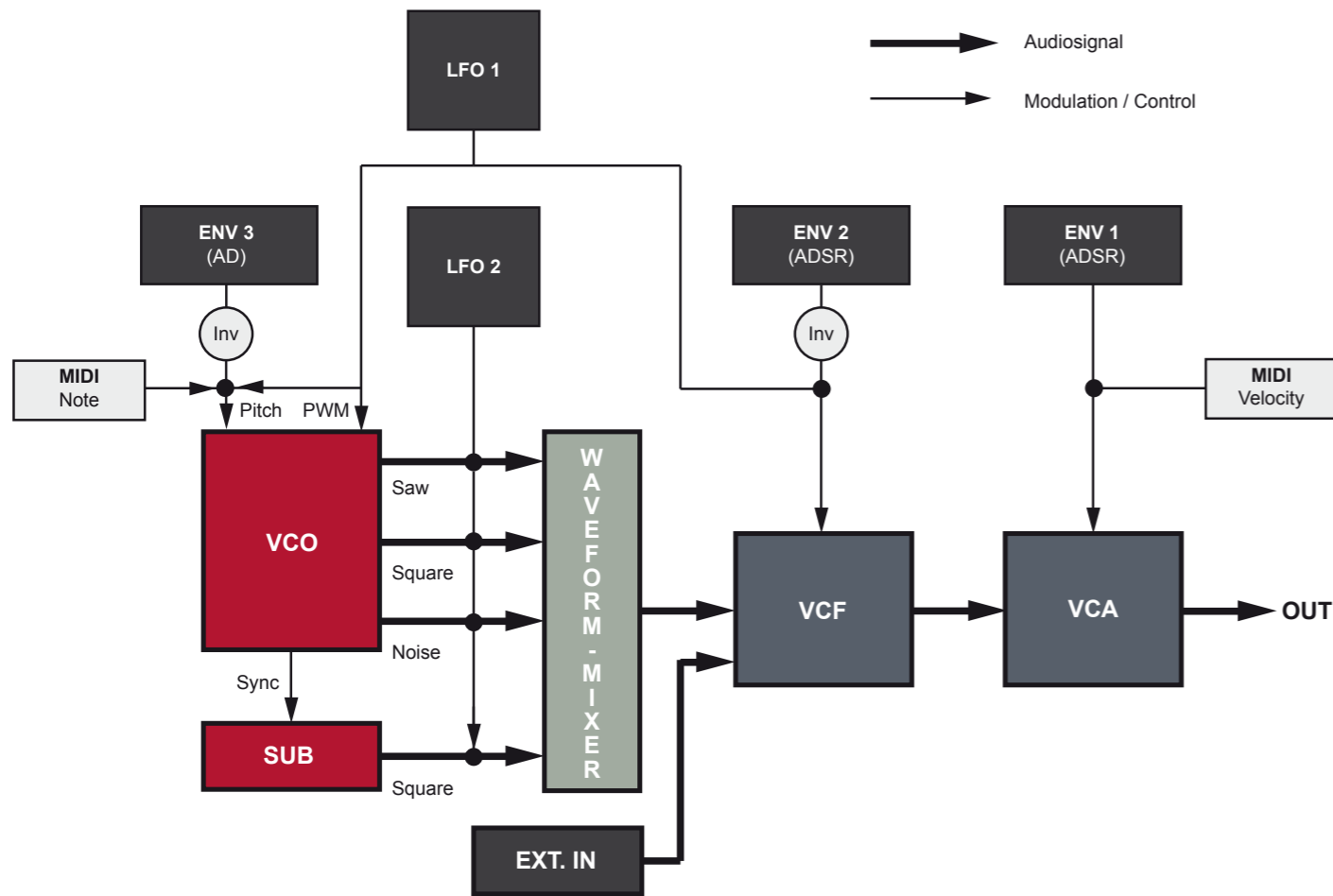

## 4. PROGRAMMING SECTION

Here you will learn all about MAGMA's programming section, introduced on page 12.

### 4.1. Preset / Pattern Handling

#### Presets and Patterns

First of all, we should distinguish between presets and patterns. A preset contains all the sequencer settings plus a specific sound setting. A pattern consists only out of the sequencer setting. That means, when changing a preset, pattern and sound will change. When changing a pattern, the sequencer will play something different but the sound currently selected remains the same (the sound, not necessarily the song...).

#### Memory Architecture

To understand MAGMA's memory architecture, please have a look at the following figure. There are four banks of eight sub-banks each. Each sub-bank contains eight presets. This makes a total of 256 presets. Exactly the same goes for the patterns. That's quite a lot of fun to be had.

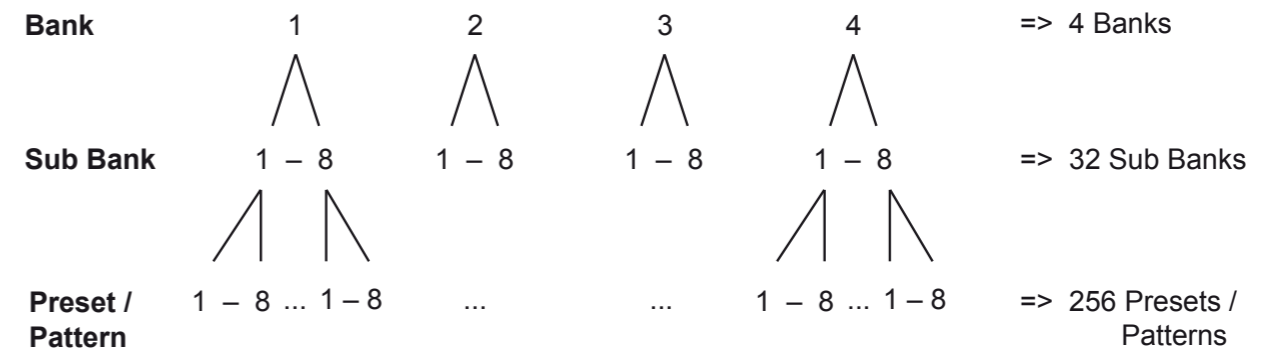

#### 4.1.1. Loading a bank

- Hit **SHIFT** (hold) + **BANK** to enter the bank select menu



- Turn **VAL** to select bank 1 – 4.

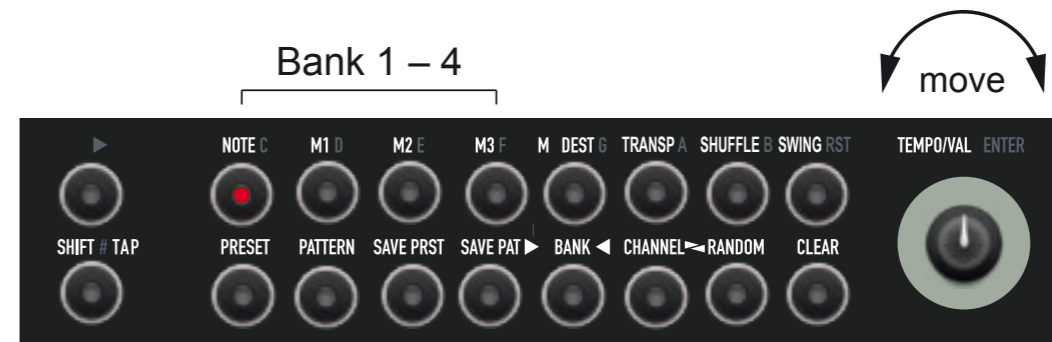





4.1.2. Loading a preset

As mentioned above, loading a preset means loading a sequence with a specific sound setting.

- Hit **SHIFT** (hold) + **PRESET** to enter the preset select menu.

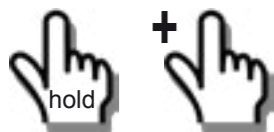
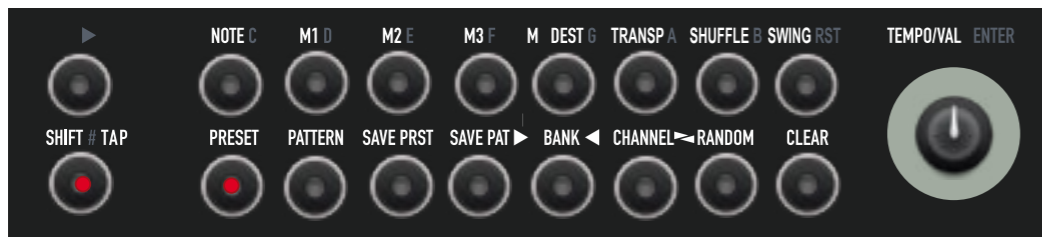

- Hit and hold a **BUTTON** in the lower row (sub bank) and hit a **BUTTON** in the upper row (preset) to select sub-bank and preset. You may also use the **VALUE** encoder instead of hitting a button in the upper row if this is more convenient for you.

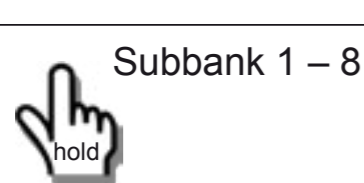
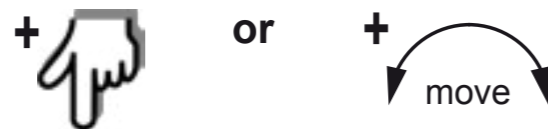

4.1.3. Loading a pattern

When a pattern is loaded, only the sequence is loaded. The audible sound setting matches the last preset active. Changing a pattern means changing just the sequence. The current sound setting remains the same (the sound, but not the song...).

If necessary, select a bank at first. See 4.1.1. on page 15. Then go on like this to select a pattern:

- Hit **SHIFT** (hold) + **PATTERN** to enter the pattern select menu.

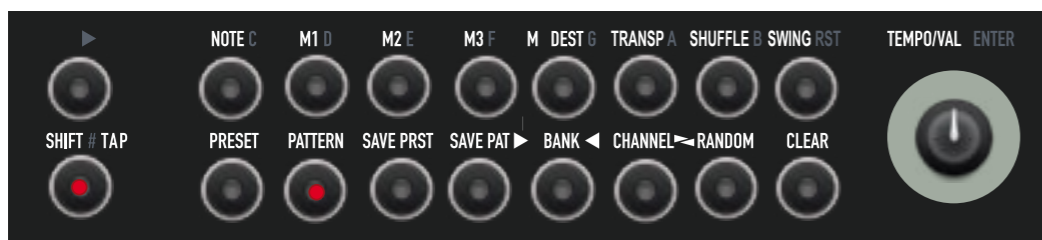

- Hit and hold a **BUTTON** in the lower row (sub bank) and a **BUTTON** in the upper row (pattern) to select sub-bank and pattern. You may also use the **VALUE** encoder instead of hitting a button in the upper row. Convenience, you know.

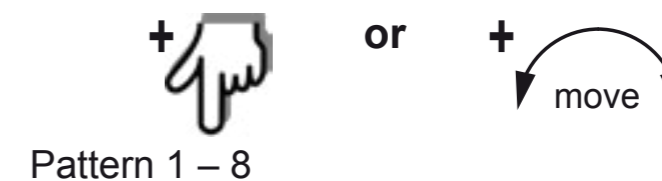

4.2. Programming a preset

Let's have a closer look at MAGMA's on-board sequencer – it is pretty powerful, and it is lots of fun. And, with a little bit of practice, it is easy to operate as well.

The following figure explains the sequencer's architecture: It has four tracks. They run in parallel and have 16 steps each. Each step is displayed by a button that can be set and programmed to contain different data:

- Track 1 ("NOTE") contains notes and note-length. It is the "actual" sequence.
- Track 2, 3 and 4 ("M1", "M2", "M3") can be assigned to any of MAGMA's sound parameters (i. e. controls). Every single one of the active steps can contain a specific value of the assigned parameter. This way, up to three different parameters can be automated by the sequencer at a time.

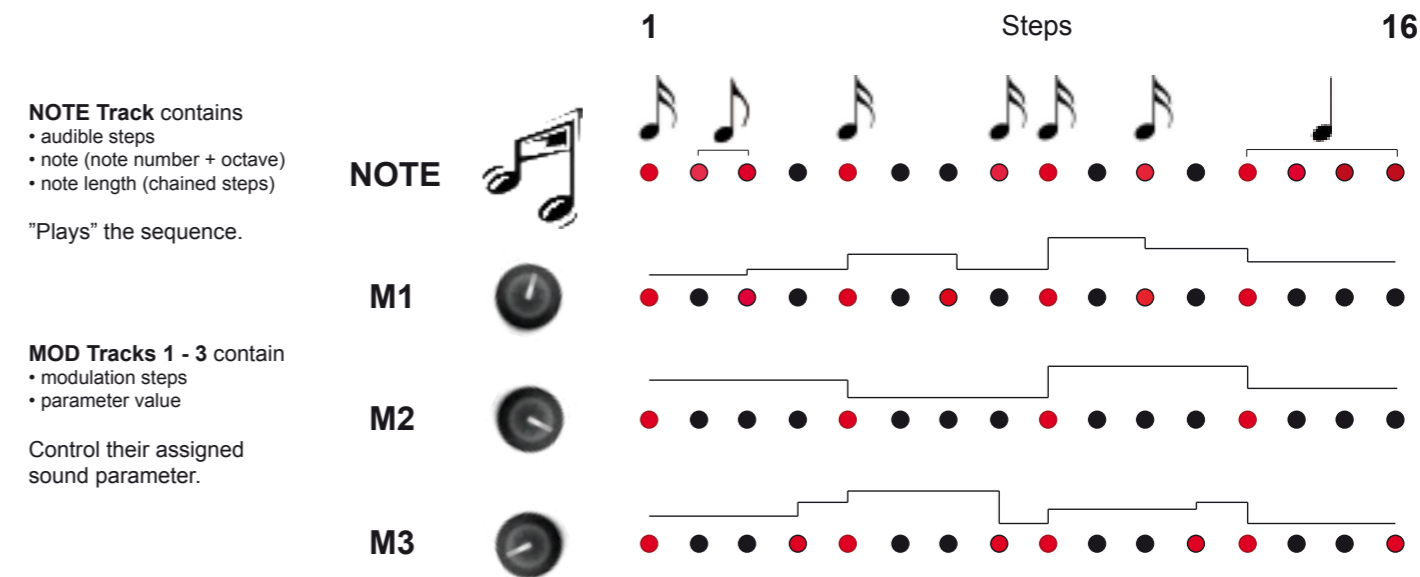



This is how to program the four sequencer tracks:



Note: Maybe it is necessary to make room for a new preset first. In this case, please refer to page 27, section 4.5., "Clearing notes, presets..."

4.2.1. Setting notes

Obviously, it makes sense to start with track 1, the note track. It is up to you, if you program the sequence while the Sequencer is stopped or running.

- Hit **SHIFT** (hold) + **NOTE** to enter the note track.



- Hit **STEPS** to enable / disable step(s). Active step(s) light up.

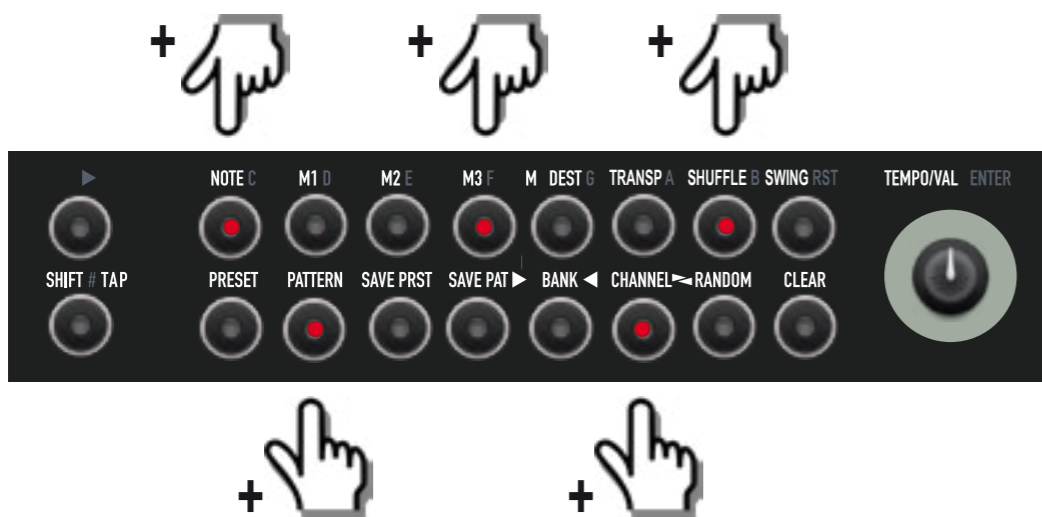

Please note: When editing an existing preset / pattern, it is necessary to enter note track first to enable / disable steps and / or access the following programming steps 4.2.2. "note length" and 4.2.3. "note pitch".

4.2.2. Note length

Each step creates a note which means the sequence is divided into 16 1/16 notes. 1/16 is the shortest available note-length. It is easy to program longer notes:

Let's assume you have already entered the note track and set some steps for a wonderful sequence (see above).



- Hit a **STEP** (hold) + another successive **STEP**. Now you have created one single long note. By using odd step numbers, you can program dotted notes.

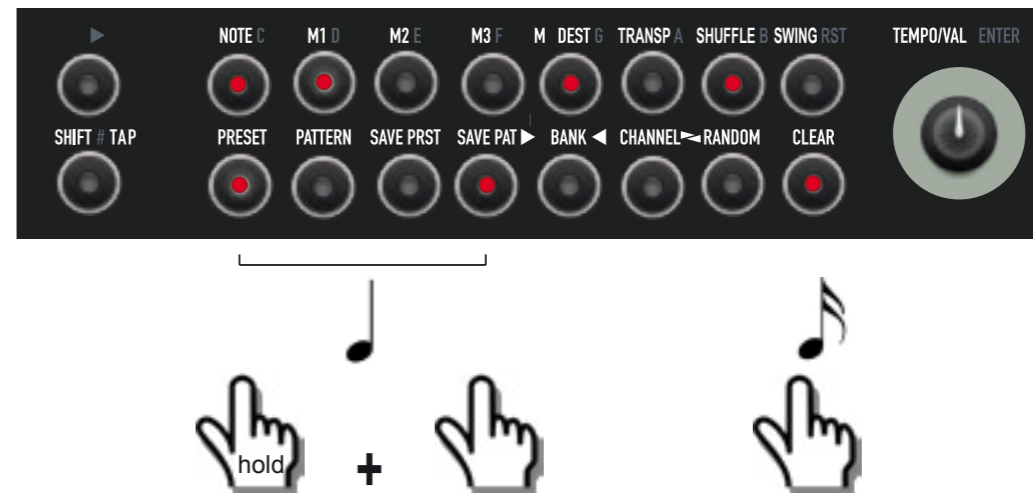

4.2.3. Note pitch

By default, each note set in an empty sequence is pitched at C. To program different notes (i. e. melodies or something more adventurous), please

- Hit a **STEP** (hold) + turn the **VALUE** encoder.

Select Step No.

Select Note



upper LED shows selected note  
white "keys" displayed  
black "keys" not displayed



lower LED shows selected octave

As long as a step button is depressed, the upper row of steps becomes a one-octave "keyboard" showing



all the "white keys". By turning the **VALUE** encoder, you select a note. To access the "black keys", simply observe the **LED** readout when turning the value encoder: A dark **LED** between two illuminated steps (e.g. between "C" and "D") means, a "sharp C"/"C#" is programmed. When turning the value encoder a bit further, you may notice that the **LED** in the lower row also changes. The lower row displays the octave setting of the selected note. Carry on programming all desired notes in the same way until you have created a nice sequence. Rest assured that, if it pleases you, it will please us (and others) as well.

4.2.4. Mod tracks

We mentioned this at the beginning of this section: The three other tracks provide control over MAGMA's sound parameters. They dynamically change value settings of assigned parameters. To program these tracks, please

- Hit **SHIFT** (hold) + **M DEST** to enter the mod destination function.



- Hit **START/STOP** to start the sequencer.



- Hit **M1** to select the desired mod track.

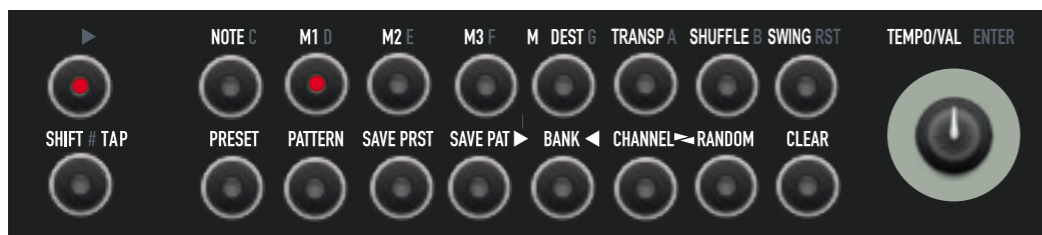

- Hit a **STEP** to select it and keep it depressed while moving the desired **PARAMETER** knob. This value will be stored in the selected step. Hit more steps and program alternative parameter values into them.

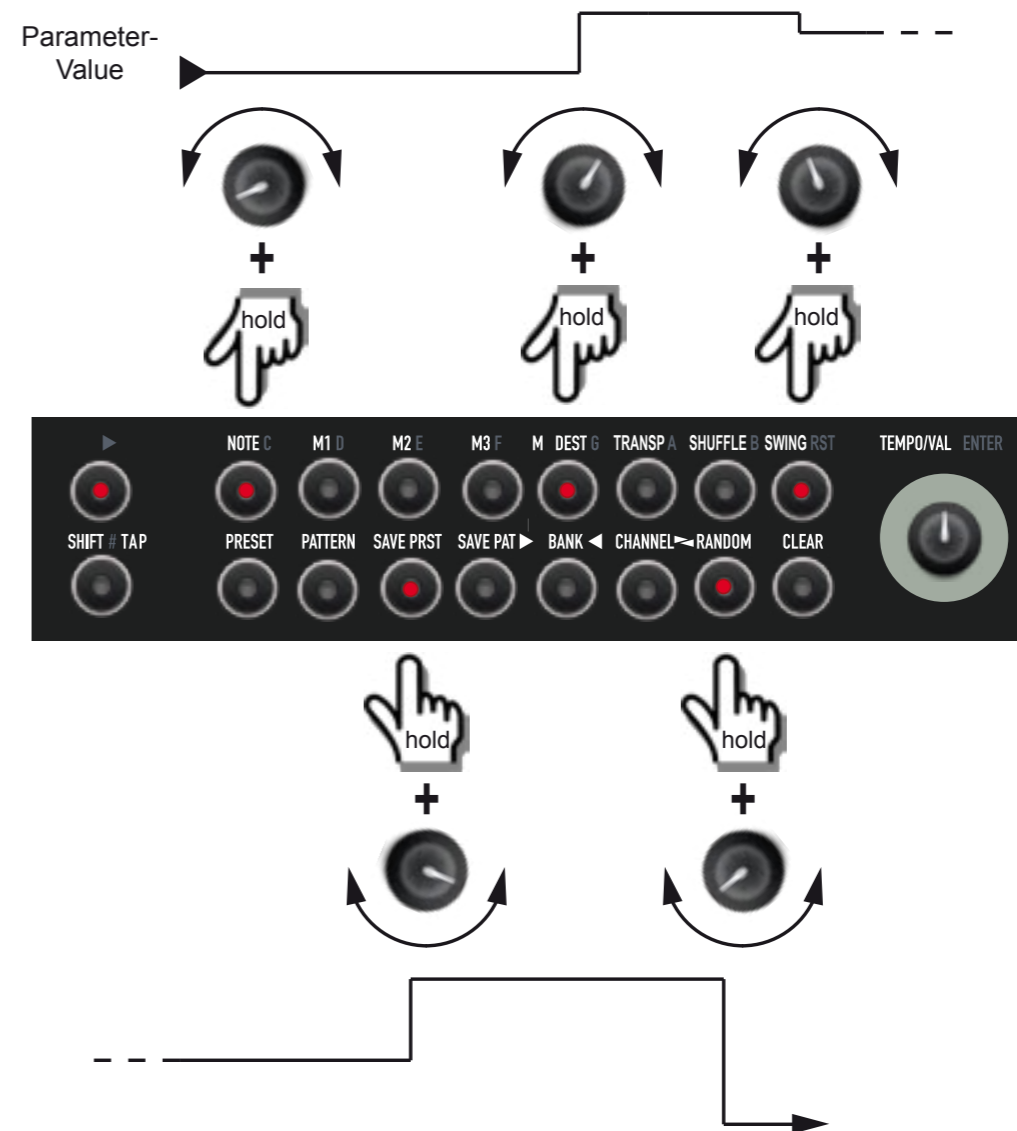

To program another mod track, please

- Hit again **SHIFT** (hold) + **M DEST** to assign a new modulation destination (see above).
- Hit **M2** to select the second mod track.

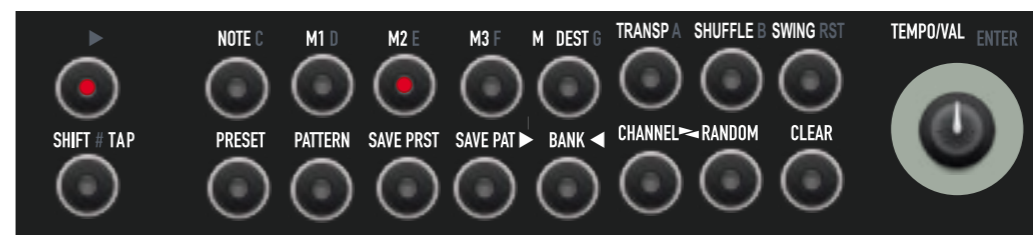



- Hit a **STEP** to select it and keep it depressed while moving the desired **PARAMETER** knob. This value will be stored in the selected step (see above).
- Hit more steps and program alternative parameter values into them (see above).

Perform the same procedure to program parameter values into mod track 3.

Please note that the selected steps on each mod track do not have to comply with the steps selected in the note track. All four tracks may have completely different step settings.

Please also note that some parameters can also be controlled by the LFO which may cause unexpected or undesired changes in sound. Please consider this when setting mod track values and / or disable the LFO. The LFO is explained in section 5.7. on page XX.

#### 4.2.5. Track Length

A track does not necessarily have to have a length of 16 steps. Each track (note, M1, M2, M3) can have individual step counts from 1 to 16 steps. In order to shorten a track, you have to define its last step. Let's pretend you want the note track to have only 8 steps:

- Hit **SHIFT** (hold) + **NOTE** to enter the note track (the same goes for mod tracks M1 - M3).

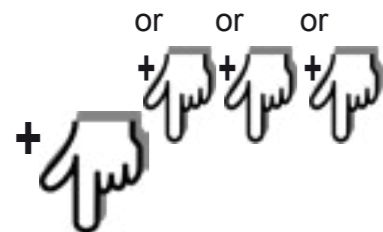

- Hit a **STEP** (hold) + hit **ENTER**.

New Track Length



In the example above, the note track now runs from step 1 to step 8. Step 9 is **not** the last played step but the "turning point".

#### 4.2.6. Swing

To add a more "groovy" feel to a preset / pattern, you can dial in a swing amount for the sequence MAGMA is running. This means that steps 1, 5, 9 and 13 are delayed or accelerated by a certain factor. To program a swing factor, please

- Hit **SHIFT** (hold) + **SWING** to enter the swing function.

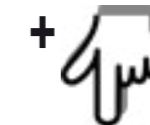

- Turn **VALUE** to select the swing amount. The two illuminated central **LEDs** indicate "no swing". Shifting the **LED** to the left accelerates the "swing" steps gradually, shifting it to the right delays the steps progressively.

Select Swing factor



upper LED row shows Shuffle amount  
more early      no swing      more delay

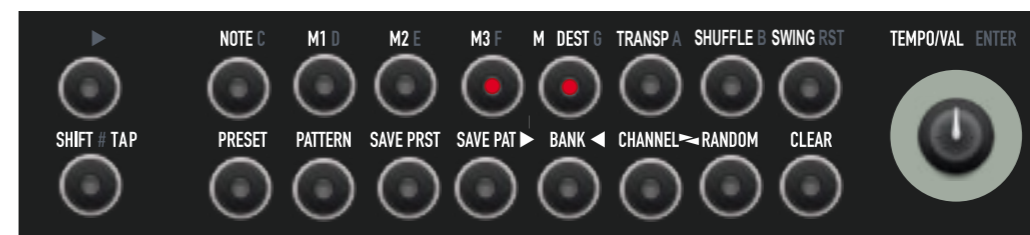

#### 4.2.7. Shuffle

To provide an even more "groovy" feel to a preset / pattern, MAGMA can also provide a shuffle amount for individual steps of the sequence. In contrast to the swing function, individual steps can have individual acceleration or delay values. To program shuffle amounts, please turn the page and...



- Hit **SHIFT** (hold) + **SHUFFLE** to enter the shuffle function.

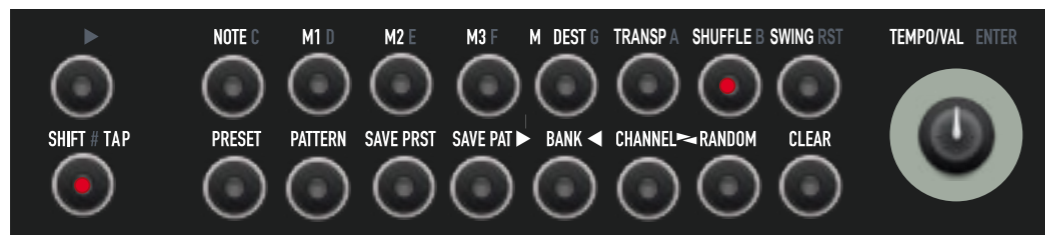
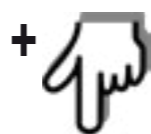

- Hit a **STEP** (hold) + move **VALUE** to select a step and its shuffle amount. Again, the two illuminated central **LEDs** mean "no shuffle". Shifting the **LED** to the left accelerates the selected step gradually, shifting it to the right delays the selected step progressively.

Select Note



Select Shuffle factor



upper LED row shows Shuffle amount

more early      no shuffle      more delay



Please note that swing settings overwrite a shuffle setting.

At this point you may know all the steps necessary to programming cool, rocking sequences with your MAGMA. Enjoy yourself!



### 4.3. Saving Presets

You want to save your new creation, we presume? That is rather easy to do:

- Hit **SHIFT** (hold) + **SAVE PRST** to enter the save preset function.



- Hit **ENTER** to save the new preset to the current location.



Please note: **This will overwrite** the preset previously stored in this place! Make sure that this is really your intention – there is **NO undo function** on MAGMA! If you accidentally erase one preset, just remember the old saying, „All things must pass.“

To select another location for storing the preset, please

- Hit and hold a **BUTTON** in the lower row (sub-bank) + hit a **BUTTON** in the upper row (preset) to select sub-bank and preset location. You can also use the **VALUE** encoder instead of hitting a button in the upper row.

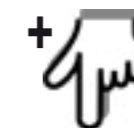

or



Preset 1 – 8

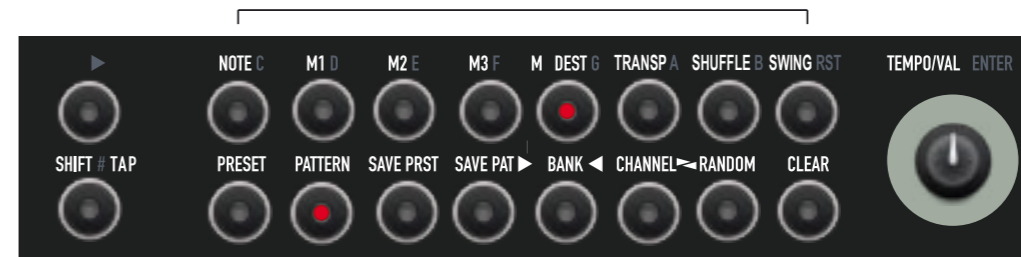

Subbank 1 – 8



- Hit **ENTER** (value encoder) to save the new preset to the selected memory location.



### 4.4. Save Patterns

Saving your new creation as a pattern works exactly the same way as saving a preset. Please keep in mind that a pattern contains nothing but the notes (and swing / shuffle settings) of a sequence – no sound settings and therefore no mod tracks. Saving a preset as a pattern works in principle, but this means losing the mod track settings.

To save a pattern, please

- Hit **SHIFT** (hold) + **SAVE PAT** to enter the save pattern function.



- Hit **ENTER** to save the new pattern to the current location (this step is not shown in the picture).



Please note: **This will overwrite** the pattern previously stored in this place! Make sure that this is really your intention – there is **NO undo function** on MAGMA! Have we mentioned the „All things must pass“ quote already?

To select another location for storing the pattern, please

- Hit and hold a **BUTTON** in the lower row (sub-bank) + hit a **BUTTON** in the upper row (pattern) to select sub-bank and pattern location. You can also use the **VALUE** encoder instead of hitting a button in the upper row.

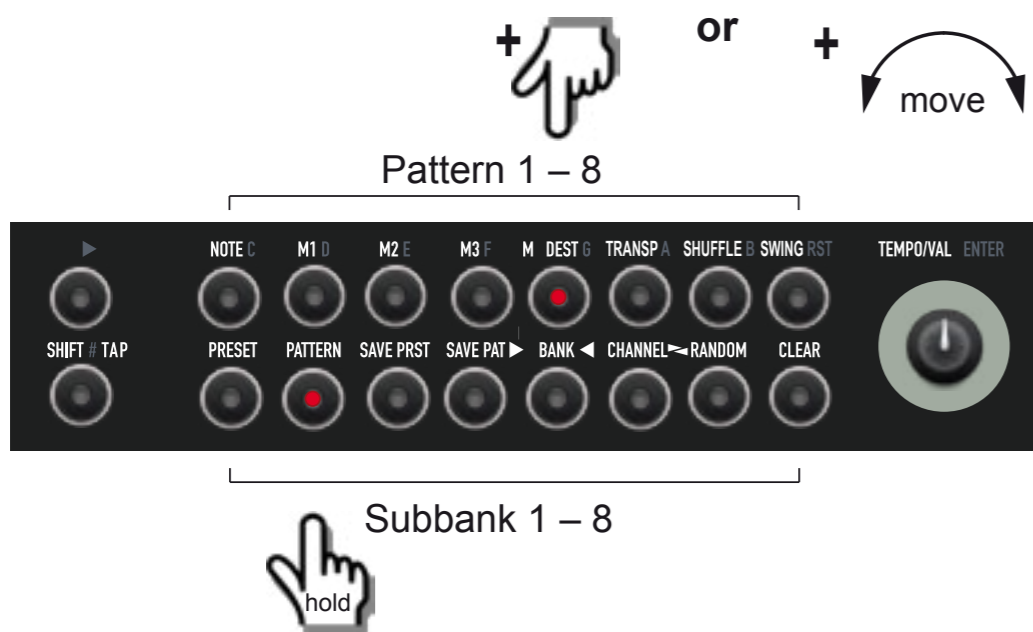

- Hit **ENTER** to save the new pattern to the selected memory location (this step is not shown in the picture).



### 4.5. Clearing Notes, Presets, Patterns, Shuffle, M1 - M3

Not all of your creations might have had your Master's Touch. Do not fear, you can easily get rid of them and make room for what really brings out your musical wit.

MAGMA's clear function gives access to every aspect you have previously programmed:

- Clear presets: clears the entire preset (sequencer and sound settings)
- Clear pattern: clears the pattern (all sequencer settings)
- Clear notes: clears the notes of a preset or pattern (note track of the sequencer)
- Clear M1 - M3: clears the selected mod track of a pattern
- Clear shuffle: clears the shuffle settings of the selected preset or pattern.

To use the clear function, please

First, select the desired preset, pattern and, where necessary, any additional function you want to erase.

- Hit **SHIFT** (hold) + **PRESET** or **PATTERN** or **NOTE** or **M1-M3** or **SHUFFLE**

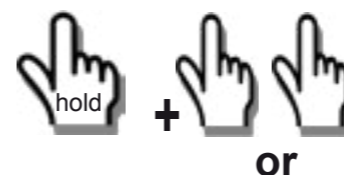
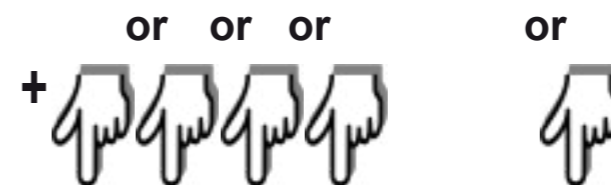

- Hit **SHIFT** (hold) + **CLEAR**

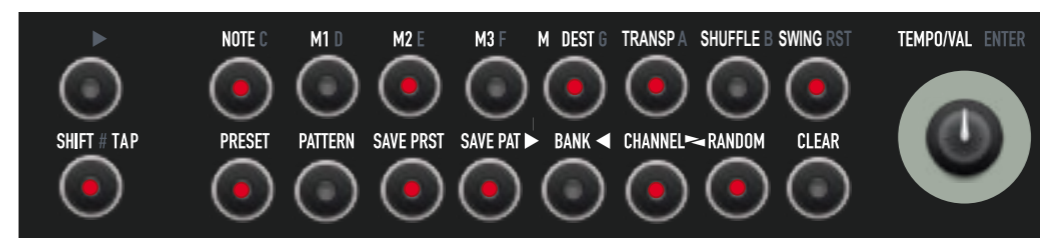

Please note that there is **NO UNDO function** on MAGMA – once cleared, there is no way to retrieve a preset, pattern etc.! So please think twice before hitting the clear button! Once it is gone, it will be gone for good.



### 4.6. Transpose Menu

The transpose menu not only offers a function to transpose the current preset / pattern in semitones, it also opens up a second function level which accesses some real-time processing functions of the preset / pattern currently selected.

To enter the transpose menu, please

- Hit **SHIFT** (hold) + **TRANPOSE**

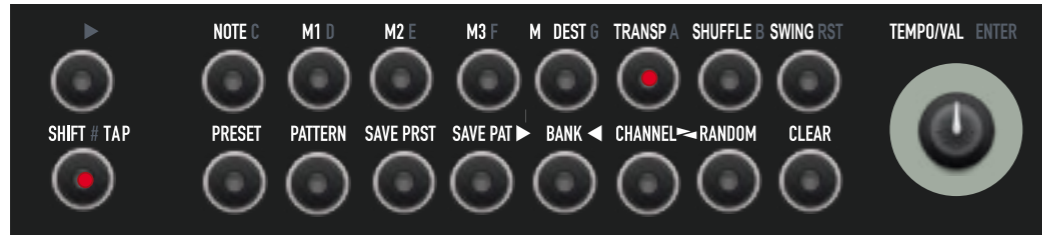
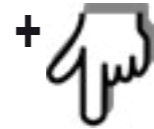

Now most buttons have been assigned to a second layer of functions, according to the following figure.

**VAL** transposes current sequence  
upper LED row shows selected note  
lower LED row shows selected octave

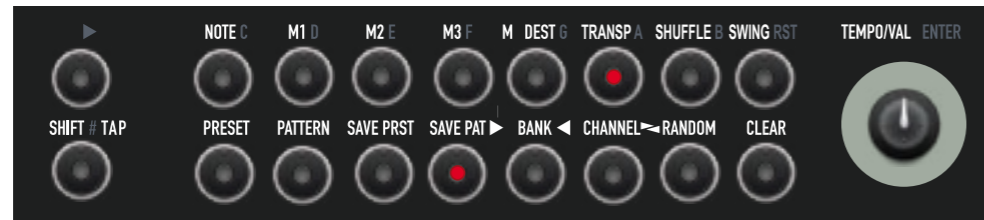

**SHIFT + TRANSP** accesses 2nd function level for lower buttons

**PRESET** toggles single/multi trigger

**PATTERN** toggles glide on/off

**SAVE PRST** toggles LFO sync on/off

**RANDOM** randomises current sequence

▶ running direction back and forth

◀ running direction backwards

▶ running direction forwards



### 4.6.1. Transpose Function

After entering the transpose menu, the transpose function is active. Simply turn the **VALUE** encoder to transpose the preset / pattern sequence in semitones.

The display of the selected transpose interval works exactly as in the note menu when programming a sequence – please refer to page 19:

The upper row of LEDs turns into a "one-octave keyboard". To access the "black keys", simply observe the LEDs when turning the value encoder: A dark LED between two illuminated steps (e.g. between "C" and "D") means, a "sharp C / C#" is programmed.

When tweaking the value encoder a bit further, you may notice that the LEDs in the lower row also change. The lower row displays the octave setting of the transposition.

This setting will not be stored as a part of a preset or pattern but will remain in memory after powering MAGMA down.



*You can simply transpose a preset or pattern in real time, either via MIDI notes transmitted from a MIDI keyboard connected, or via another MIDI controller device of your choice. Please note that the velocity data transmitted by your MIDI device will directly affect the volume of the current sequence.*

### 4.6.2. Single / Multi Trigger

Hit **PRESET** to toggle between single and multiple triggering when receiving MIDI notes from an external MIDI device.

- Multi Trigger (PRESET LED off): Every incoming MIDI note-on command will trigger a note. (default setting).
- Single Trigger (PRESET LED on): New notes will be triggered only after MAGMA has received a MIDI-note off command.

This setting will be stored as a part of a preset or pattern.

### 4.6.3. Glide on / off

Hit **PATTERN** to toggle between glide function on / off.

- Glide on (PATTERN LED on): The pitch of every new note played slides up or down from the note played previously.
- Glide off (PATTERN LED off): Only notes played legato (via external MIDI device) will slide (default setting).

Use the **GLIDE** knob to adjust the slide time.

This setting will be stored as a part of a preset or pattern.

### 4.6.4. LFO Sync

Hit **SAVE PRST** to toggle between LFO sync on / off.

- LFO sync on (SAVE PRST LED on): Both LFOs are synced to the clock of MAGMA's on-board sequencer. If MAGMA receives an external MIDI clock signal, his clock will become the time-base for MAGMA's sequencer and / or the LFOs. Turning the **SPEED** knob will change the LFO-speed stepwise in fractions of musical note durations.
- LFO sync off (SAVE PRST LED off): Both of MAGMA's LFOs run independently.

This setting will be stored as a part of a preset or pattern.



### 4.6.5. Sequencer Running Direction

Hitting one of the buttons labelled , , determines the direction in which the current preset / pattern will run.

- (LED on): Sequencer is running forwards from left to right (default setting). Hit the (start) button to start the sequence on step 1. You may use this in real time as a performance feature.
- (LED on): Sequencer is running backwards.
- (LED on): Sequencer is running back and forth like a pendulum. First and last step are only played once.

### 4.6.6. Random Sequence

Hit **RANDOM** to randomise the sequence. The results will differ, depending on whether you were in preset or pattern mode before using the random function:

- Randomising out of pattern mode will randomise the steps and note pitches.
- Randomising out of preset mode will randomise the steps, note pitch, and the values of the current setting of MAGMA's sound generation.

Hitting , or will "restore" the sequence to its original state. If you want to keep the result of the randomisation, please store it as pattern or preset. Without storing, the randomised sequence will be lost after changing to a new preset / pattern, or after powering MAGMA down. You will find all about the store functions on pages 25, 26.

### 4.7. Clock Divider

The four sequencer tracks can run at different tempo ratios. For each track, you can select a clock divider which can be a value from 1 to 16. Each value corresponds to a fraction of the master clock tempo (tempo setting of the internal sequencer or an external MIDI clock). This will allow you to create complex sounding sequences with just a bit of programming effort.

To select different tempo ratios, please

- Hit **SHIFT** (hold) + **NOTE** or **M1** or **M2** or **M3** to select a track.

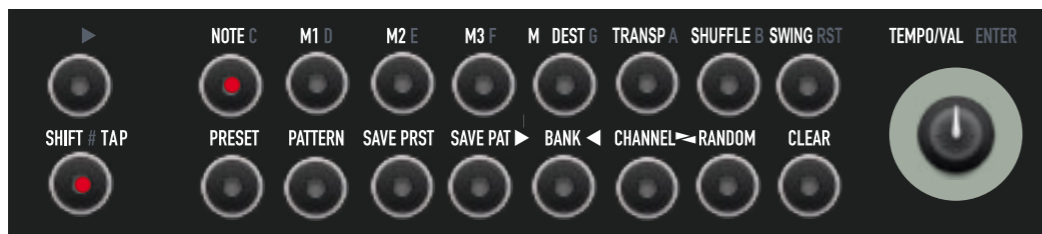
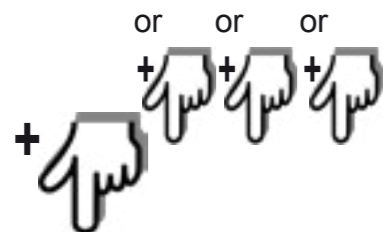

- Hit **SHIFT** (hold) + **PLAY** (hold) + **VALUE**
- Turning **VALUE** will light up **LED 1** to **16**, displaying the corresponding tempo fraction for the selected track.

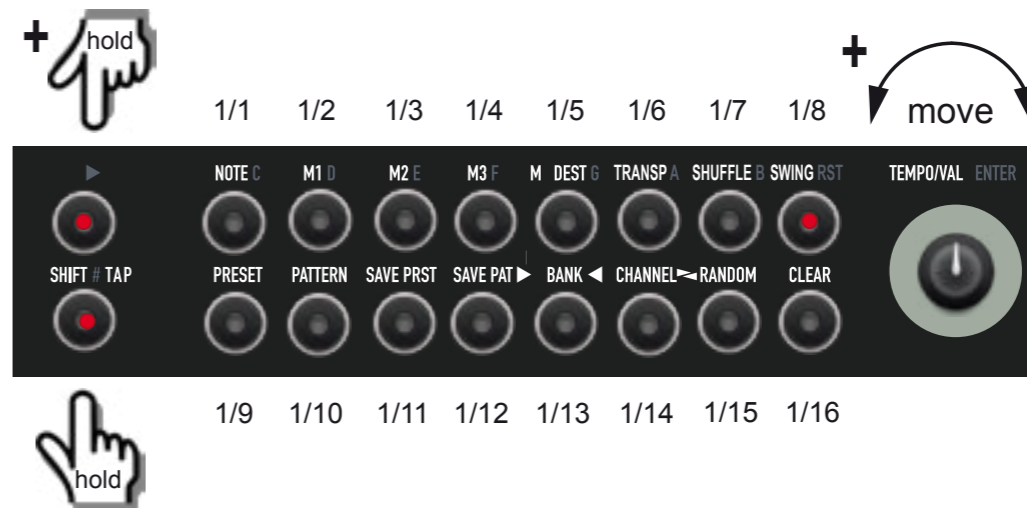

This setting will be stored as part of a preset / pattern.

### 4.8. Chaining Patterns

In pattern mode, you can easily daisy-chain two or more patterns to form a longer "composition".

- Hit **SHIFT** (hold) + **PATTERN**  
This will enter pattern mode.







- Hit lower **STEP** (hold) + upper **STEP**  
This will load the first preset of the chain.
- Hit first upper **STEP** (hold) + more upper **STEPS**.  
All selected patterns in the current sub-bank will be played in sequence.

Select up to 8 patterns to be chained



Select Sub Bank

This function is designed as a real-time feature. There is no way to store chains of patterns. Please note that only patterns from the same sub-bank can be daisy-chained.

You should not chain patterns with different clock divider settings active. Under some circumstances, MAGMA might get confused. You cannot cause damage this way, but unwanted effects and erratic behaviour might ensue. Always a good thing when experienced five minutes before a live show on TV.

#### 4.9. MIDI Channel

Use this function to select MAGMA's MIDI channel. This setting defines the input and output MIDI channel. To select a MIDI channel, please

- Hit **SHIFT** (hold) + **CHANNEL**

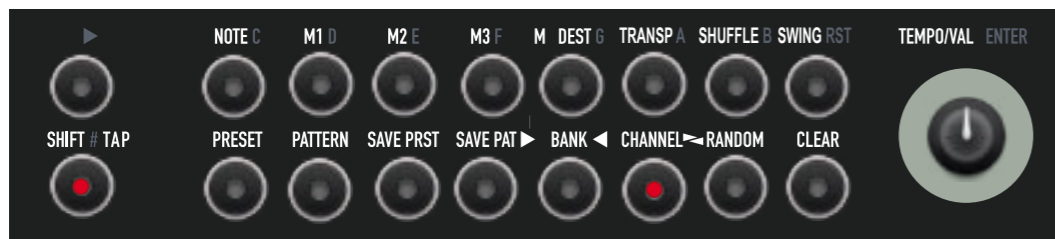

- Turn **VALUE**

The illuminated **LED** on steps 1 to 16 indicates the number of the selected MIDI channel 1 to 16.

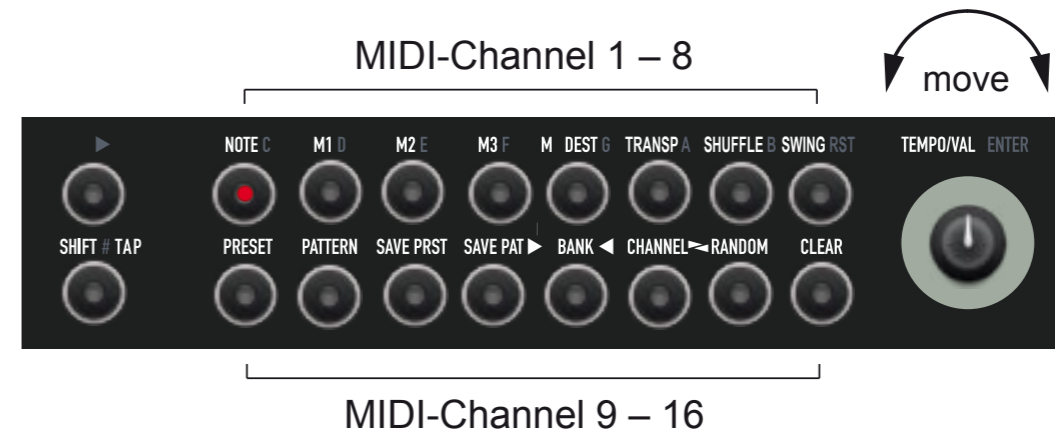

Please note that this setting is kept in memory while MAGMA is powered down.



## 5. SOUND GENERATION

MAGMA sports a fully-fledged monophonic synthesiser with fully analogue signal path – best suited for powerful synthesiser hook-lines, melodies, and bass. The best way for MAGMA to unfold its sonic potential lies in conjunction with its on-board sequencer. Playing MAGMA via an external MIDI device will also yield great results, though.

Now that you have successfully managed MAGMA’s menu-based functions, you will easily get your teeth into the synthesiser section.

### 5.1. Sound Generation Overview

The following two figures will briefly display all sections and functions of MAGMA’s sound generation. More detailed explanations will follow, please be patient. Please do not forget to carry on reading since the panel has some interesting secrets to hide.

Most – but not all – of the pots (there, we said it again!) have direct access to just one single parameter, labelled on MAGMA’s control panel. The buttons have several settings, displayed by specific LED combinations.

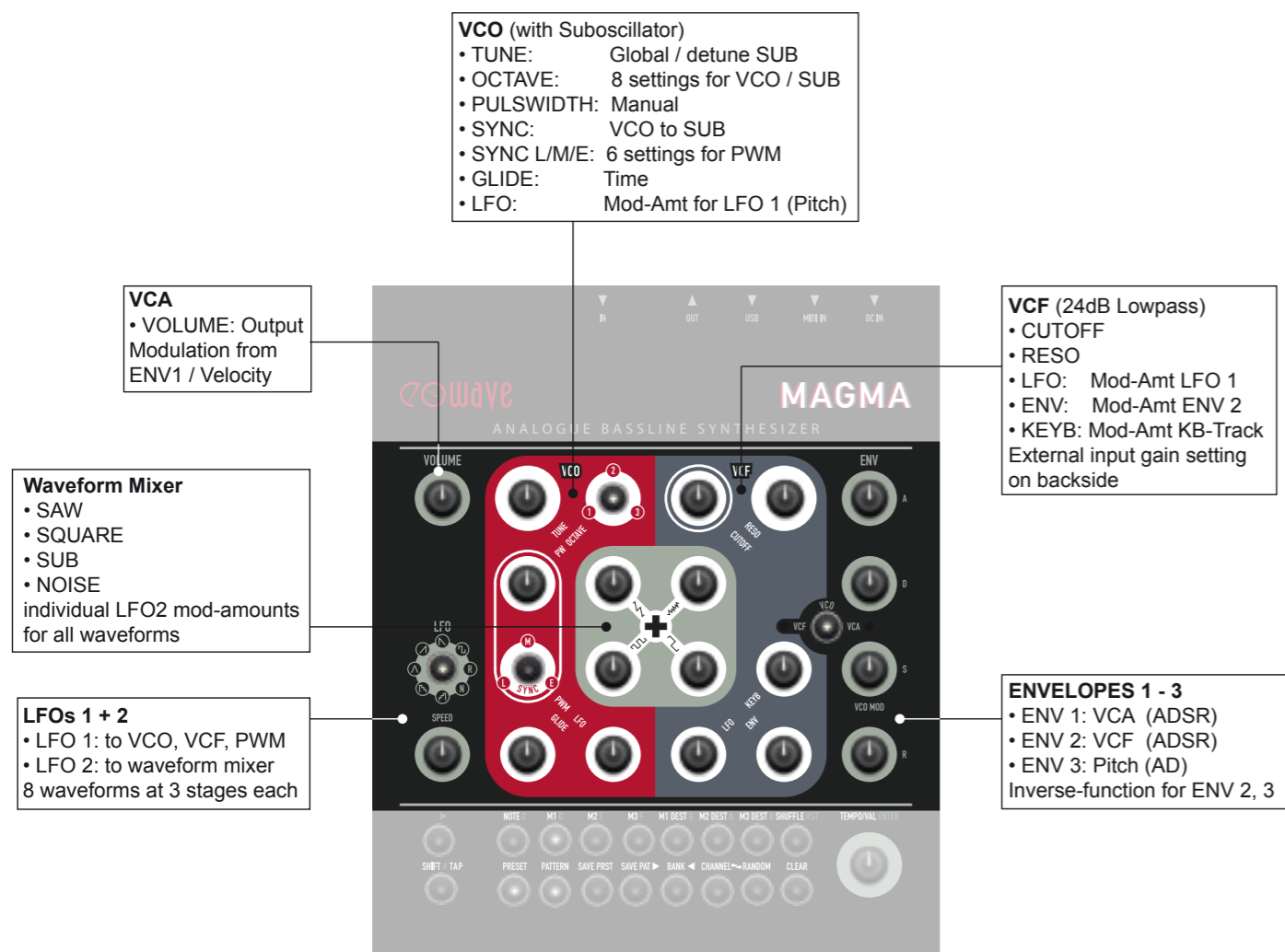

This is what’s to be found under the hood of MAGMA’s sound generation. All sections are labelled in a specific colour, corresponding to MAGMA’s front-panel layout.

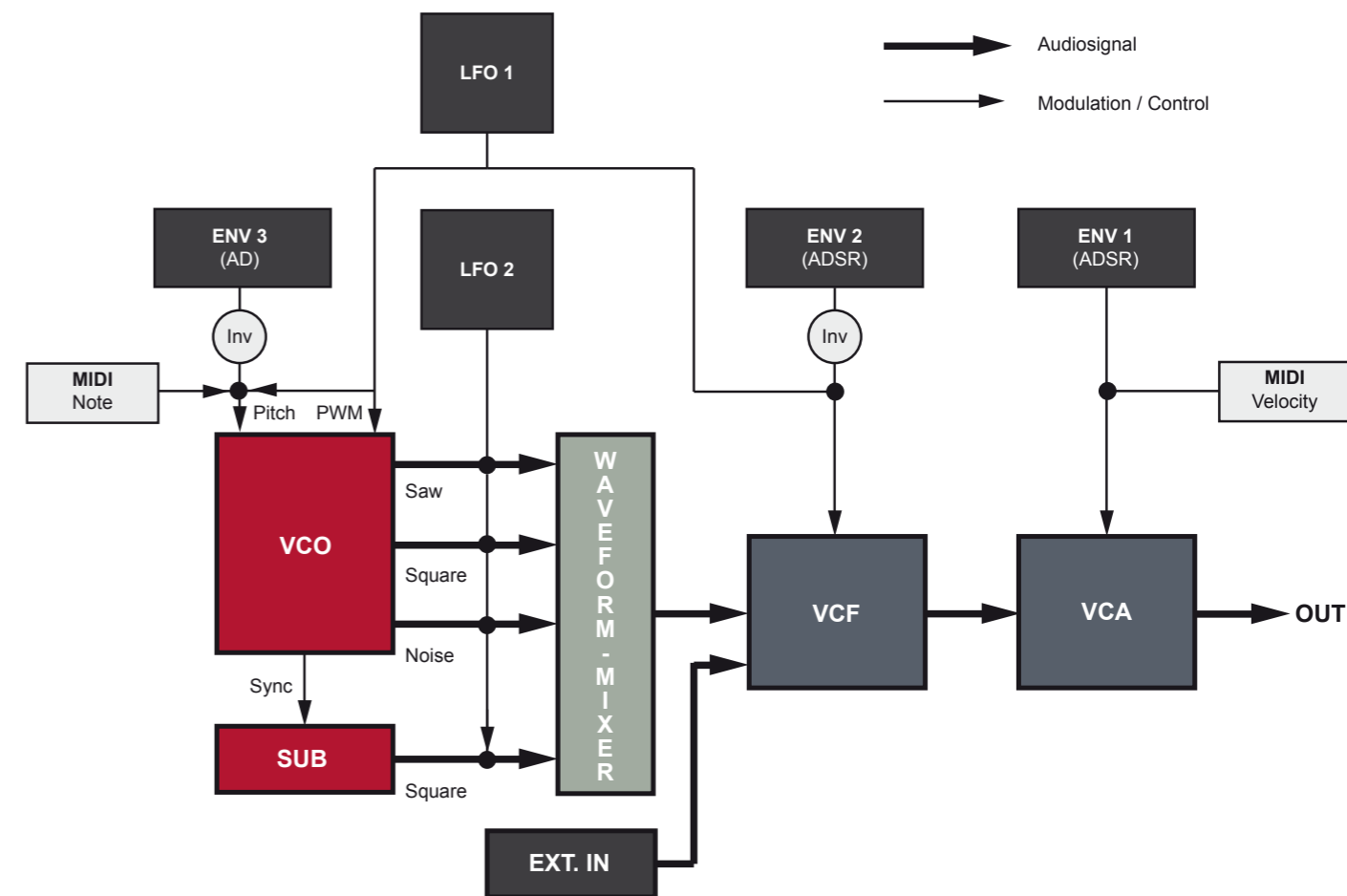

The sound sources comprise the voltage-controlled oscillator (VCO) and a sub-oscillator (SUB), phase-synced to the VCO. They both send their waveforms into the mixer and further on into the voltage-controlled filter (VCF) as well as the voltage-controlled amplifier (VCA). There is also an external input fed into the filter/amplifier section (for processing external signals, more about this later).

Have a closer look at the two envelopes and the way they are connected to their modulation destinations: ENV2 controls the VCA, ENV1 can be inverted and controls VCF and VCO pitch. LFO 2 controls the mixer, LFO 1 has a go at VCO pitch as well as pulse-width of the square-wave. It can be inverted as well.

Finally, we find MIDI data (that is, the on-board sequencer) controlling pitch and triggering ENV 2 to generate notes.



5.2. Oscillator (VCO) / Mixer

The VCO is MAGMA's main signal source. It provides the basic waveforms to the module next in line, the mixer. The VCO section is endowed with a sub oscillator which derives its output from the VCO's square-wave. A closer look at all the controls will explain the functions of both VCO and mixer.

5.2.1. Mixer



The mixer is the output stage of MAGMA's oscillator. All signals provided by the VCO are summed together into one audio-signal.

- : Level of **SAW** wave signal.
- : Level of **SQUARE** wave signal.
- : Level of **SUB** oscillator signal.
- : Level of the **NOISE** signal.

Cranking up all four signals fully will cause saturation and distortion. This can be very useful to fatten up MAGMA's sound. If you want a clean sound, we recommend you keeping the level knobs below the 3 o'clock setting.

All four signal levels can be individually modulated by LFO 2.

Hit **SHIFT** and keep it depressed while moving one of the **WAVEFORM** knobs as this will apply a specific modulation depth to the selected waveform level.

5.2.1. VCO

**TUNE:**  
Global tune. Tunes the VCO and the sub-oscillator within the range of one semitone. The tune setting will not be stored as part of a preset.

**OCTAVE:**

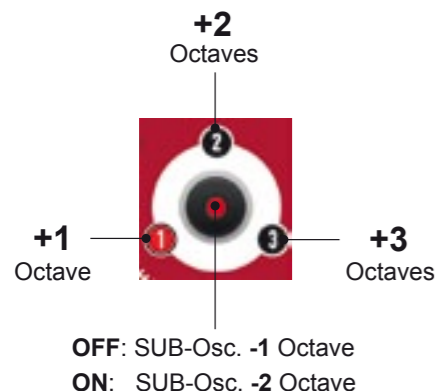

Controls the octave setting of both the VCO and the sub oscillator. The three LEDs around the octave button display the octave setting of the VCO. The LED in the central button displays the octave setting of the sub-oscillator, depending on the setting of the VCO.

Hit the button eight times to cycle through all possible settings.

**PW:**  
Controls the PULSE-WIDTH of the square-wave manually from 50% to 95%. When the pulse-width of the square-wave is modulated (see below), this knob controls the modulation depth applied by LFO 1 or envelope 2.



SYNC / PWM:

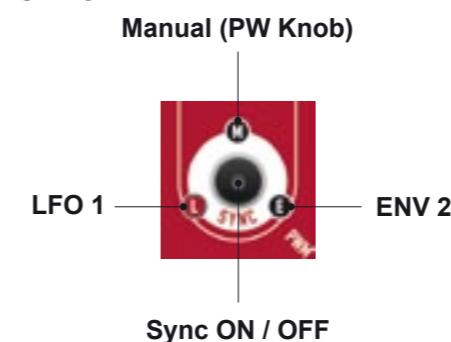

This button has two related functions. Firstly, it synchronises the sub-oscillator to the VCO which will result in interesting timbres when changing the pitch of the VCO. Secondly, it selects the modulation source for the pulse-width modulation (PWM) of the square-wave. The three LEDs around the sync button display the PWM source. The LED in the button displays the state of the oscillator-sync function.

Hit the button six times to cycle through all possible settings.

**GLIDE:**  
Adjusts the glide time when the glide function is active. Please refer to section 4.6.3. on page 29 how to enable / disable the glide function.

**LFO:**  
Adjusts the modulation depth of LFO 1, modulating VCO pitch.

5.3. Filter (VCF)

MAGMA's filter is a classic 24 dB / four-pole low-pass design with resonance and great sonic potential. Let's have a closer look at it:



**CUTOFF:**  
Adjusts the cut-off frequency. When turned fully counter-clockwise, there might be no signal audible (no-pass, so to speak...).

**RESO:**  
Adjusts the resonance intensity of the filter. Higher settings will cause the filter to self-oscillate which results in feedback. Please handle the resonance pot (here it is again!) with care – feedback might reach excessive levels, depending on the cut-off frequency setting. Do not blow your tweeters or your ear-drums!

The lower three knobs are used to modulate the filter cut-off frequency:

**LFO:**  
Adjusts the modulation depth of LFO 1 modulating the VCF cut-off frequency.

**ENV:**  
Adjusts the modulation depth of envelope 2 modulating the VCF cut-off frequency. Pressing **SHIFT** while moving the ENV knob will yield an inverted modulation curve.

**KEYB:**  
Adjusts the keyboard tracking value of the VCF frequency. Keyboard tracking makes higher notes sound increasingly brighter.

You can run an external audio signal (e.g. a drum machine) into MAGMA's filter for processing sound. Connect this signal (line level) to the Input socket on MAGMA's rear panel. Adjust the input level with the trimmer found next to the input socket. Please note that the external signal has to have line level. The signal is fed directly into the filter input, thus it will only be attenuated, not amplified.



5.4. Amplifier (VCA)



The VCA has only one single control – the **VOLUME** knob. It adjusts the output level of MAGMA’s audio output. Its setting is not saved as part of a preset.

Dynamic level control is achieved by envelope 1 and MIDI velocity data.

5.6. Envelope section

MAGMA is equipped with three envelope generators for modulation tasks. Envelopes 1 and 2 are fully-featured ADSR types, envelope 3 is of a more basic AD variety. Please refer to the following two figures to get an idea of what the envelope parameters are about.



The two envelopes are connected to different functions:

- Envelope 1 controls the VCA, that is, the signal level.
- Envelope 2 controls VCF cut-off frequency, that is, the brightness of the sound.
- Envelope 3 controls VCO pitch.

The envelope controls are:



- **A:** Attack time (envelope 1,2,3)
- **D:** Decay time (envelope 1,2,3)
- **S:** Sustain level (envelope 1,2)
- **R:** Release time (envelope 1,2)

To connect each envelope with the ADSR controls, hit the **ENV** button up to three times.

An "active" ENV 3 is displayed by illuminated VCF and VCA LEDs. When ENV 3 (VCO) is active, the **D** knob controls the modulation depth of ENV 3 modulating the VCO pitch. Pressing **SHIFT** while moving the **D** knob will yield an inverted modulation response.



The LED in the button will light up as soon as MAGMA generates a trigger signal from the on-board sequencer or receives external MIDI data.



5.7. LFOs



MAGMA provides you with two LFOs (Low Frequency Oscillators) for even more complex modulation madness. Both LFOs generate several waveforms and can be synced to MAGMA’s on-board sequencer / MIDI clock. Both LFOs have identical features but different modulation targets.

- LFO 1 modulates VCO pitch, VCF cut-off and PW (pulse-width of the VCO square wave).
- LFO 2 modulates the levels of the four oscillator waveforms.

Since all LFO functions are controlled by just one single button and a bunch of LEDs, please read the following section carefully.

LFO 1 / LFO 2 access

Keep **SHIFT** depressed while performing any further LFO adjustments, controlling LFO 2. Releasing **SHIFT** routes the controls back to LFO 1.

LFO Waveforms

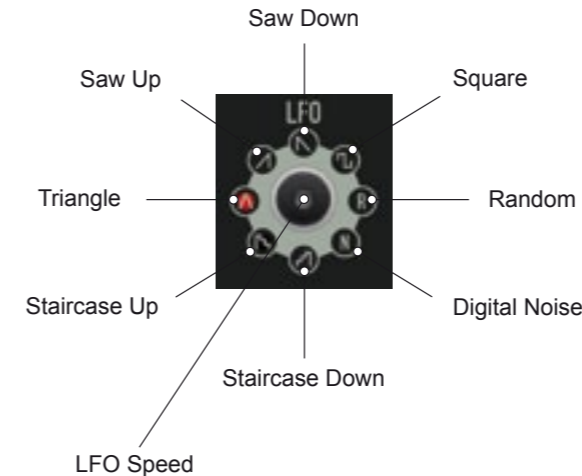

When having a closer look at the LEDs around the LFO button, you will notice little symbols on each one – if not, we advise you to go and see your optician (no pun intended)...

Each LED represents one of the eight waveforms available.

LFO Mode

Both LFOs can operate in three different modes:

- Normal: The LFO oscillates constantly at a given rate.
- Reset: The LFO starts its cycle with each new note-on command.
- One shot: The LFO starts its cycle with each new note-on command but performs just one single cycle – just like a "mini envelope".

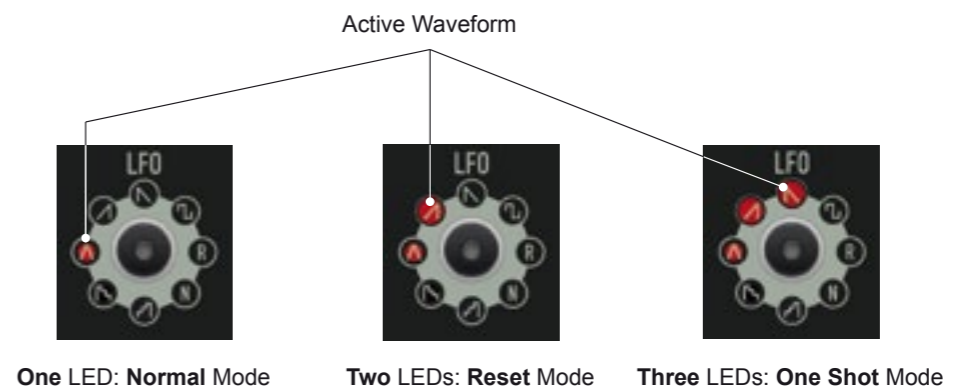



All eight waveforms can operate in all of the three modes, which results in a total of 24 different settings possible. The 24 settings the LFO can adopt (as well as the eight LEDs) is illustrated in the following figure. Clockwise, the first illuminated LED always shows the active waveform, other LEDs inform you about the current mode.

To select the desired waveform and mode, hit the **LFO** button repeatedly – in an extreme case up to 24 times.

**LFO Speed**

Turn the **SPEED** pot (oops, we said it again...) to adjust the LFO rate. The value ranges from approx. 10 seconds per cycle to 290 Hz.

Since the LFOs can run at audio frequency, you can create interesting timbres when modulating VCO pitch or VCF cut-off frequency.

**LFO Sync**

Both LFOs can be synced to the clock of MAGMA's on-board sequencer or incoming MIDI clock data respectively. If MAGMA receives an external MIDI clock signal, this clock becomes the time-base for MAGMA's sequencer and / or the LFOs.



Please keep in mind that the LFOs can behave a bit differently, depending on whether they are tempo-synced or not. If tempo-synced, the speed cannot be altered continuously but in fractions of musical note durations.



When running in sync, the LFOs have a speed range different from the one they have when running independently. The LFOs clock divider allows for a speed range from 4 bars / cycle to 1/32 note / cycle.

LFO sync on / off is a hidden function in the TRANSPOSE menu. To access this function, please

- Hit SHIFT (hold) + TRANSPOSE to enter the transpose menu.

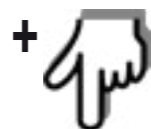

- Hit SAVE PRST to toggle between LFO sync on / off.



6. MIDI FUNCTIONS

MAGMA is designed to do a great job as stand-alone device. Still, you may team up MAGMA with some suitable companions from time to time. In order to ensure a proper communication with the outside world, MAGMA is equipped with a MIDI interface.

MAGMA's MIDI interface boasts the following features:

- USB port for MIDI in / out; DIN socket for MIDI-In.
- MIDI clock sync of MAGMA's on-board sequencer and / or MAGMA's two LFOs.
- Real-time transposition and velocity control of current sequence via MIDI notes.
- MAGMA processes MIDI controller data on the input and output side.
- Program-change processing
- Sending out sequencer notes

6.1. MIDI Connections

How to connect MAGMA with other MIDI devices is covered in section 2.3. "Connections" on page 9, 10.



Please note that USB and MIDI connections should not be made at the same time.



Please also make sure to avoid MIDI loops. A MIDI loop will occur when MAGMA is connected to a MIDI device via USB while the MIDI device's MIDI-through function is enabled. Please make sure to disable MIDI-through on the software sequencer, controller device etc. in question. Especially Steinberg Cubase users should keep this in mind since Cubase is set to MIDI-through by default.

Avoid MIDI Loops!

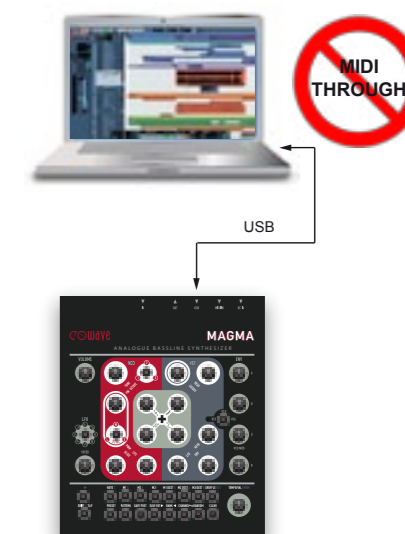

6.2. MIDI Clock Sync

MAGMA's on-board sequencer as well as its two LFOs can be synced to an incoming MIDI clock signal. As soon as MAGMA receives a MIDI clock signal at its USB port or DIN socket, the internal sequencer will automatically be tied to the MIDI clock. MAGMA's tempo dial (value knob) will be disabled as long as MAGMA receives MIDI clock data.

Please note that MIDI clock is not channel-related MIDI data.



Please do not send any MIDI time-code signals to MAGMA. MAGMA is not designed to process this type of data.

To sync MAGMA's two LFOs to MIDI clock, simply apply a MIDI clock signal to MAGMA and enable the LFO sync function. Please refer to section 5.7. "LFOs" on page 39.

### 6.3. Real-time Transposition of Sequence

In preset or pattern mode, incoming midi notes will transpose the current sequence. MAGMA also processes incoming velocity values. They directly control the volume of the sequence currently active.

The sequence currently active may also be processed using pitch and mod wheels of a MIDI controller device connected.

### 6.4. MIDI Controller Processing

MAGMA sends and processes incoming MIDI controller data. This way, all functions listed below can be remote-controlled by a MIDI controller device or MIDI sequencer. On the other hand, knob tweaking performed on MAGMA can be recorded into a MIDI sequencer as well.

MAGMA's MIDI controller processing is always active and thus does not have to be enabled or disabled.

|            |    |            |    |            |        |
|------------|----|------------|----|------------|--------|
| CUT        | 1  | SUB        | 17 | LFO2_SQR   | 33     |
| SUB_DETUNE | 2  | KB_VCF     | 18 | LFO2_SUB   | 34     |
| RES        | 3  | LFO_SPEED  | 19 | VEL_VCA    | 35     |
| ATT1       | 4  | GLIDE      | 20 | VEL_FILTER | 36     |
| DEC1       | 5  | LFO_VCO    | 21 | VEL_RES    | 37     |
| SUS1       | 6  | LFO_VCF    | 22 | SEQ1_DEST  | 38     |
| REL1       | 7  | ENV_VCF    | 23 | SEQ2_DEST  | 39     |
| ATT2       | 8  | LFO_TYP    | 24 | SEQ3_DEST  | 40     |
| DEC2       | 9  | OCTAVE     | 25 | MODWHEEL   | 41     |
| SUS2       | 10 | ATT3       | 26 | PB_RANGE   | 42     |
| REL2       | 11 | DEC3       | 27 | LFO_SYNC   | 43 (*) |
| PWM        | 12 | ENV3_VCO   | 28 | SEQ1_DIV   | 44     |
| PW         | 13 | LFO2_SPEED | 29 | SEQ2_DIV   | 45     |
| SAW        | 14 | LFO2_TYP   | 30 | SEQ3_DIV   | 46     |
| NOISE      | 15 | LFO2_SAW   | 31 | VOL        | 110    |
| SQR        | 16 | LFO2_NOISE | 32 | TUNE       | 111    |

(\*) affects also glide mode and note trig

### 6.5. Program change processing

MAGMA receives bank select and program-change data. Use bank select commands #1 to #4 to access the four preset or pattern banks. Use program change commands #1 to #64 to access the 64 presets / patterns in the bank currently selected.

### 6.6. Sending out sequencer notes

MAGMA's on-board sequencer transmits the notes programmed into a preset or pattern. Note numbers (pitch) and durations are transmitted. This way, you can record a sequence into an external MIDI sequencer.

As pointed out earlier – please make sure to avoid MIDI loops!

### Terms of warranty

EOWAVE LIMITED WARRANTY and standard legal disclaimer.

Thank you for purchasing Eowave product. The following terms and conditions apply:

1. Warranty period is for one year from the date of purchase with a proof of purchase submitted. Warranty covers electrical failure of electronic components, except in cases explained below.
2. Operating instructions must be followed. MAGMA must not have been damaged as a result of misuse, neglect, accident, destruction, improper electrical voltages or currents, repair, alteration or maintenance by any person or party other than our own service facility or an authorized service center, use of replacement parts or modification of the product in any way.
3. Obligations of Eowave shall be limited to repair or replacement with same or similar unit. To obtain repairs under this warranty, present the product and proof of purchase to Eowave service center, transportation charges prepaid. When returning the product for repair, please pack it very carefully, preferably using the original packaging materials. Please include an explanatory note.

### CE norm & FCC information

1. Important notice: do not modify this unit! This product, when installed as indicated in the instructions contained in this manual, is compatible with the CE norm & FCC requirements
2. Important! When connecting this product to accessories and/or another product, use only high quality shielded cables. Cables supplied with this product must be used. Follow all installation instructions. Failure to follow instructions could void your FCC authorisation to use this product in the USA.

**Note:** this product has been tested and found to comply with the requirements listed in FCC Regulations, Part 15 for Class B digital devices & in The European Standard EN 50081-1 on Electromagnetic Compatibility - Generic emission standard on residential, commercial and light industry. Compliance with these requirements provides a reasonable level of assurance that the use of this product in a residential environment will not result in harmful interference with other electronic devices.

### Disposal

This device complies to the EU guidelines and is manufactured RoHS conform without the use of led, mercury, cadmium and chrome. Still, this device is special waste and disposal in household waste is not permitted.

For disposal, please contact your dealer or: Eowave – La Cure – 58110 Tintury – France

### Eowave Team

MAGMA has been designed and developed by Marc Sirguy.

Graphic design: Philipp Roller

Design and export: Emmanuelle Gallin.

### Imprint

Owners Manual by Matthias Fuchs / VISOPHON, Berlin, Germany

English version tweaked and adjusted by Stephen Parsick / doombient music, Bielefeld, Germany

Copying, distribution or any commercial use in any way is prohibited and needs the written permission by the manufacturer.

Specifications subject to change without notice.

Although the content of this owners manual has been thoroughly checked for errors, Doepfer Musikelektronik GmbH cannot guarantee that it is error-free throughout. Doepfer Musikelektronik GmbH cannot be held liable for any misleading or incorrect information within this guide.

All rights reserved © 2012 Eowave



MAGMIA

QOWAYE